

► HMXL44CS-KIT User Manual

Thank you for purchasing this product.

For optimum performance and safety, please read these instructions carefully before connecting, operating or adjusting this product. Please keep this manual for future reference.



Surge protection device recommended

This product contains sensitive electrical components that may be damaged by electrical spikes, surges, electric shock, lightning strikes, etc. Use of surge protection systems is highly recommended in order to protect and extend the life of your equipment.

Safety And Performance Notice

The transmission distances of HDMI over UTP cables are measured using TE CONNECTIVITY 1427071-6

EIA/TIA-568-B termination (T568B) of cables is recommended for optimal performance.

To minimise interference of the unshielded twisted pairs in the CAT5e/6 cable do not run the HDBaseT / Cat5e/6/6a cabling with or in close parallel proximity to mains power cables.

Do not substitute or use any other power supply other than the enclosed unit, or a Blustream approved replacement.

Do not disassemble either the Transmitter or Receiver units for any reason. Doing so will void the manufacturer's warranty.

Contents

Introduction	03
Features	03
Panel Descriptions	05
Control Ports	06
HDBaseT™ Receiver Options	07
Matrix Front Panel Controls	08
Audio Breakout	09
Terminating HDBaseT™ CAT Cables	10
Understanding Matrix / RX Status Lights	10
Infrared Distribution	11
Infrared Remote Control	12
EDID Control	13
Application Diagram	14
Specifications	15
Package Contents	15
Maintenance	15
RS-232 and Telnet Commands	16-17
Infrared Commands	18-19
Web Browser Interface	20

Introduction

Our Essential 4x4 HDBase™ Matrix offers unprecedented performance and value for the custom installation market. The HMXL44CS-KIT is a HDMI 2.0 4K 60Hz 4:4:4 HDCP 2.2 Matrix package utilising HDBase™ CSC technology to deliver HDMI, bi-directional IR, RS-232 and PoC (Power over Cable) up to lengths of 70m over a single CAT cable. The matrix also provides advanced features including simultaneous HDBase™ / HDMI on output 1, video down conversion on HDBase™ output 1, audio breakout with pre-amp variable line-level control, and a web browser interface module for control and configuration of the matrix. The HMXL44CS-KIT is supplied with 4 x HEX70CS-RX HDBase™ receivers.

FEATURES:

- Advanced HDBase™ technology offering uncompressed video and audio with zero latency
- Advanced Colour Space Conversion (CSC) supports HDMI 2.0 18Gbps specification including HDR
- Features 4 x HDMI inputs which can be independently routed to 4 x HDBase™ outputs
- Output 1 features simultaneous HDMI and HDBase™ output
- Video down-conversion on HDBase™ output 1 allowing a display only capable of supporting lower video resolutions (4K 60Hz 4:2:0 or 1080p) to receive 4K 60Hz 4:4:4 video content while still showing maximum original 4K UHD resolution on the remaining video outputs
- Supports 4K 60Hz 4:4:4 UHD video up to 40m
- Extends HDMI 1080p video up to 70m
- HDMI re-clocking on the HEX70CS-RX HDBase™ receiver to help solve HDMI HDCP, compatibility and handshaking issues
- Supports all industry standard video resolutions including VGA-WUXGA and 480i-4K
- Supports all known HDMI audio formats including Dolby TrueHD, Dolby Atmos, Dolby Digital Plus and DTS-HD Master Audio transmission
- HDMI audio breakout to associated analogue L/R audio outputs with pre-amp line level control
- Analogue audio input can be embedded onto any HDMI input
- Web interface module for control and configuration of matrix
- Supports bi-directional IR and RS-232 on all HDBase™ outputs
- Supplied with Blustream 5V IR receivers and emitters
- Control via front panel, IR, RS-232, TCP/IP, or iOS / Android App
- Supports PoC (Power over Cable) to power supplied Blustream HDBase™ receivers
- 1U design for 19" rack mount integration - mounting kit included
- Advanced EDID management
- HDCP 2.2 compliant

Colour Space Conversion (CSC) Technology in HDBaseT™

Due to the data rate of HDBaseT™ technology being capped at 10.2Gbps, it is unable to pass the latest native 4K UHD resolutions of 4K 60Hz 4:4:4. There is now a requirement to integrate video resolutions with data speeds up to 18Gbps across a multi-zone AV environment. Blustream have implemented CSC (Colour Space Conversion) technology into our latest products to ensure 4K HDR signals can now be supported over the limited infrastructure of HDBaseT™.

Colour Space Conversion reduces the data rate of the HDMI signal by converting the colour space from 4:4:4 or 4:2:2 to a lower format. Within Colour Space Conversion technology the native resolution and frame rate remain constant from end to end. The only part of the signal that is converted during transmission is the colour.

Blustream CSC products do not support HDR10+ or the dynamic variation of Dolby Vision due to the way these specific variations of dynamic HDR (dHDR) are encoded. These codecs transmit repeated metadata packets throughout the transmission of any media making it impossible at this stage to convert in the same way using CSC technology.

Scaling Technology on Output 1 of the HMXL44CS-KIT

The Blustream HMXL44CS matrix features in-built scaling technology on output 1. This scaling is automatic when output 1 detects a legacy 4K or 1080p display and all source material is automatically downscaled. The output resolution is changed, but the refresh rate of the content is kept the same. i.e. 4K 30Hz is downscaled to 1080p 30Hz. Please note, the scaling is only on the HDBaseT™ connection of output 1 and will only downscale the video to a 4K 4:2:0 or 1080p video format.

Panel Descriptions

Front Panel

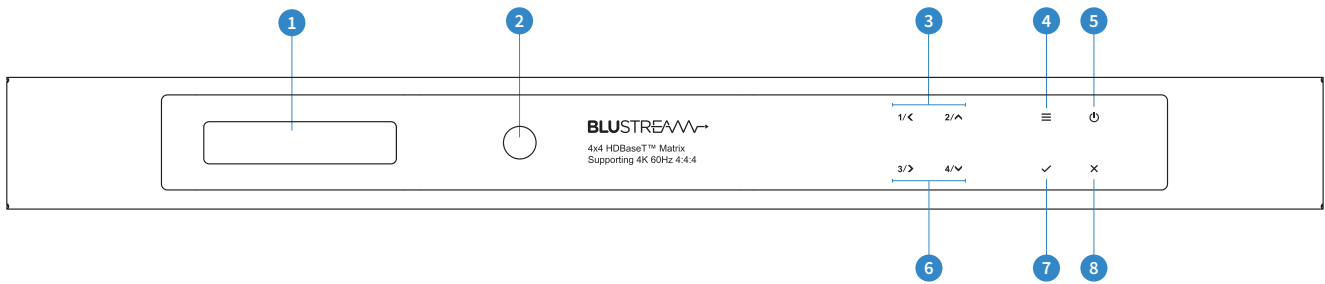

- 1 LCD Display – Shows the status of input / output selection, EDID etc
- 2 IR Receiver Window
- 3 1 / 2 / Left / Up Selection Buttons - Press select input / output 1 or 2, or to change segment value
- 4 Menu Button - Press to enter set-up menu
- 5 Power button – Press to power on / off the matrix
- 6 3 / 4 / Right / Down Selection Buttons - Press select input / output 3 or 4, or to change segment value
- 7 Enter Button – Press to select or confirm command / selection
- 8 ESC – Press to quit EDID set mode

Rear Panel

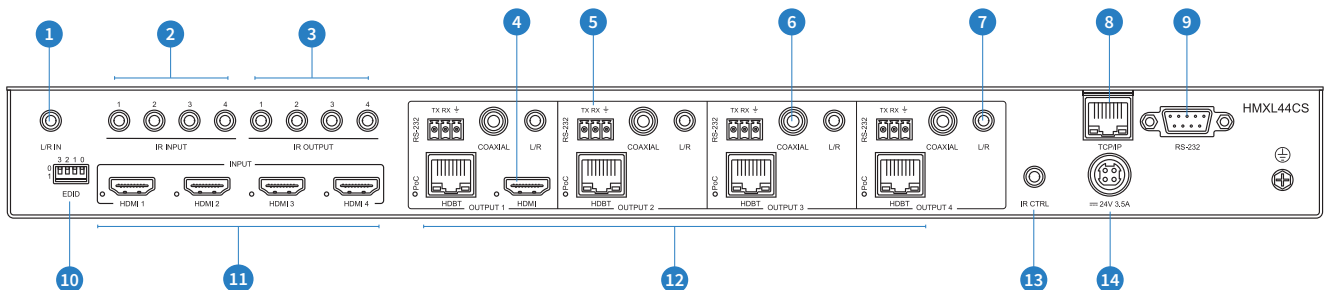

- 1 L/R In - 3.5mm Analogue audio input for embedding audio onto HDMI inputs
- 2 IR Inputs 1 to 4 – 3.5mm stereo jack. Sends 5V IR out to corresponding HDBaseT™ zones
- 3 IR Outputs 1 to 4 – 3.5mm mono jack. Routed IR 5V emitter outputs for discrete source control
- 4 HDMI Output 1 – Output for HDMI display (linked to HDBaseT™ Output 1)
- 5 RS-232 Pass-through Port (x4) - Sends RS-232 out to corresponding HDBaseT™ zones
- 6 Coaxial Digital Audio Output (x4) – Extracted audio will be concurrent with the corresponding HDMI video output
- 7 Variable L/R Line Level Analogue Audio Outputs (3.5mm stereo jack) (x4) – Extracted audio will be concurrent with the corresponding HDMI video output. **Note:** input must be PCM 2ch audio as Matrix does not down-mix 5.1ch audio signals
- 8 TCP/IP (RJ45) – Connect to LAN for TCP/IP control of Matrix and Web GUI
- 9 RS-232 Port – For control of the Matrix from PC or third party control processor
- 10 EDID DIP Switch – Used for global EDID settings
- 11 HDMI Inputs 1 to 4 – Connect HDMI sources
- 12 HDBT Outputs 1 to 4 – Output for displays. Connect to HDBaseT™ Receiver
- 13 IR CTRL Receiver Input – 3.5mm stereo jack. 5V input for connection of a remote IR sensor or control processor for remote IR control of the matrix
- 14 Power Port – Use included 24V/3.5A DC adaptor to power the matrix switcher and HDBaseT™ receivers

HMXL44CS-KIT Control Ports

The HMXL44CS-KIT main communication ports are located on the rear panel and includes the following connections:

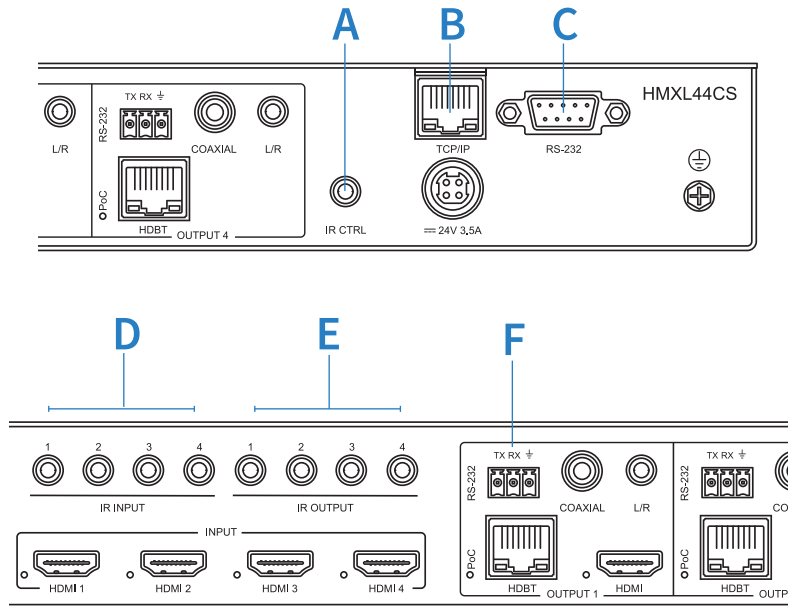

Connections:

- A. Global IR Input 3.5mm stereo jack - For control of the Matrix Switcher*
- B. TCP/IP – For control of the Matrix (RJ45 Connector)
- C. RS-232 – For control of the Matrix (9 pin serial connection)
- D. IR Input (3.5mm stereo jack) for IR pass-through to the associated output HDBaseT Receiver*
- E. IR Output (3.5mm mono jack) for routed IR control of source equipment*
- F. RS-232 (3-pin Phoenix connector) for 2-way RS-232 pass-through to the associated output HDBaseT Receiver

***Note** - Blustream products use 5V IR hardware. For further details please see page ‘Infrared Distribution’.

Blustream’s HMXL44CS matrix is supplied with all required 5V IR emitters, receivers and IRCAB cables.

TCP/IP

The Blustream HMXL44CS matrix can be controlled via TCP/IP.

For the full list of protocols please see ‘HMXL44CS Control Protocols’ located at the rear of this manual.

The HMXL44CS matrix features a built-in web browser user interface allowing control and configuration of the matrix. For further details please see page 18 ‘Web Browser User Interface’.

A ‘straight-through’ RJ45 patch lead should be used

RS-232 2-Way

The Blustream matrix can be controlled via a 9-pin serial cable.

For the full list of protocols please see ‘HMXL44CS Control Protocols’ located at the rear of this manual.

Details of RS-232 pin assignment and communication are adjacent. Please note that depending on your control device serial port pin configuration you may require either a ‘Straight’ RS-232 cable or ‘Null-modem’ type.

BLUSTREAM RS-232		REMOTE CONTROL CONSOLE	
PIN	Assignment	PIN	Assignment
1	NC	1	NC
2	Tx	2	Rx
3	Rx	3	Tx
4	NC	4	NC
5	GND	5	GND
6	NC	6	NC
7	NC	7	NC
8	NC	8	NC
9	NC	9	NC

Baud Rate: 57600 bps

Data Bit: 8-bit

Parity: None

Stop Bit: 1-bit

Flow Control: None

HMXL44CS-KIT HDBaseT™ Receivers

The HMXL44CS matrix is supplied with 4 x HEX70CS-RX HDBaseT™ receivers

The HEX70CS receiver is a Class B HDBaseT™ receiver with 2-way IR and bi-directional RS-232 pass-through. The receiver supports display distances up to 70m @ 1080p and 40m 4K (4K 60Hz 4:4:4 / 18Gbps at input).

Panel Descriptions HEX70CS-RX

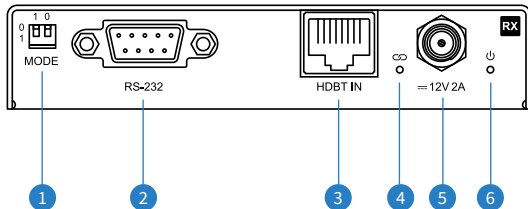

- 1 Mode Dip-switch - To switch RS-232 serial port between pass-through and firmware update mode
- 2 RS-232 / Serial Connector
- 3 HDBaseT™ Input
- 4 HDBaseT™ Signal Link Indicator
- 5 DC 12V Screw Type Connector
- 6 Power Status Indicator

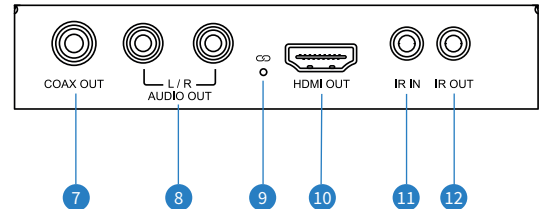

- 7 Coaxial Digital Output - De-embedded from HDMI input
- 8 Analogue Audio Left / Right Output (3.5mm stereo jack de-embedded from HDMI input. Supports stereo 2ch PCM audio only)
- 9 HDMI Signal Link Indicator
- 10 HDMI Output
- 11 IR IN (to Blustream 5V 3.5mm IR receiver)
- 12 IR OUT (to Blustream 5V 3.5mm IR emitter)

Matrix Front Panel Control

Front Panel Display - Input / Output Selection

The following display shows current source input selection per zone output.

1. To change input selection first press 'OUTPUT' button (1-4)
2. Press desired 'INPUT' button (1-4)
3. An 'X' indicates that the zone output has been turned off.

Zones can be turned on/off using RS-232/TCP/IP commands.

Zone outputs can be forced back on by powering OFF/ON the matrix. All outputs will be turned on when powered up.

Zone outputs can be forced back on by pressing and holding 'OUTPUT 1' button on the front panel for 10 seconds. The matrix will reset and all outputs will be turned back on.

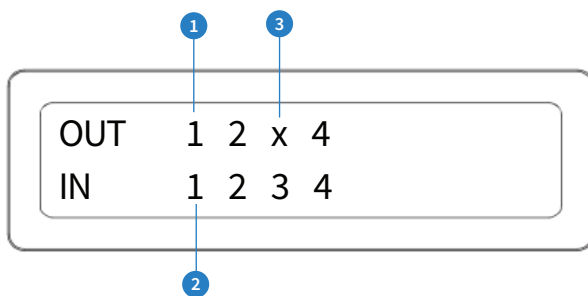

EDID Management - Global or Individual Input Settings

The following characters show adjusting the EDID for 'All' inputs (Global). Current EDID value is set to 1080p & 2ch audio.

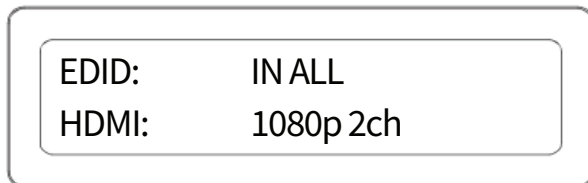

To change the input signal type using the Matrix front panel buttons press the following:

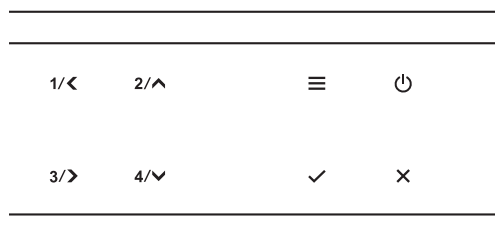

Using Matrix Front Panel Buttons

- A. Press **MENU** button
- B. Panel will display 'EDID settings'. Press **SELECT** button
- C. Select the input you wish to fix the EDID on (1-8) or select 'All'. Use **UP/DOWN** buttons to toggle selection and **SELECT** button to confirm
- D. Select video resolution required (4K, 1080p, 3D etc). Use **UP/DOWN** buttons to toggle selection and **SELECT** button to confirm
- E. Select audio resolution required (2ch, 5.1 or 7.1). Use **UP/DOWN** buttons to toggle selection and **SELECT** button to confirm
- F. Press the **ESC** button to exit

Audio Breakout

The HMXL44CS matrix includes audio breakout from the selected HDMI input to associated analogue L/R audio and coaxial digital outputs. Extracted audio will be concurrent with the corresponding HDMI video output.

The HMXL44CS analogue outputs include pre-amp line level control allowing you to connect the Blustream matrix directly into a power amplifier for all your multi-room audio needs.

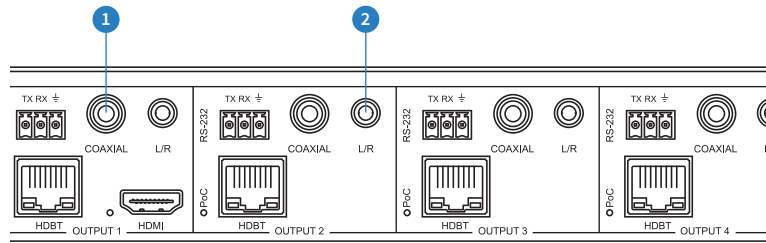

1. Coaxial digital output - Output 1
2. Analogue pre-amp line level output 3.5mm stereo jack - Output 2

Control of the pre-amp line level outputs is via RS-232, TCP/IP or using the in-built web browser interface. Please see 'RS-232 & Telnet Commands' for further details.

Note: Volume control is only available on the analogue audio outputs. Source input must be PCM 2ch audio for analogue audio outputs to work. The HMXL44CS matrix does not down-mix 5.1ch audio signals.

Volume control of audio outputs is not possible via Infrared control.

Terminating the Interconnecting HDBaseT™ CAT Cable

It is important that the interconnecting CAT cable between the Blustream HDBaseT products is terminated using the correct RJ45 pin configuration. The link CAT cable **MUST** be a 'straight' (pin-to-pin) CAT cable and it is advised that this is wired to the T568B wiring standard as this format is less prone to EMI (Electro-Magnetic Interference).

When installing CAT cables it is advised that you use the best possible CAT cable quality possible. HDMI distribution products will only work if used with CAT5e standard cable or above. Blustream recommends using a CAT6 cable for your installations, especially when running over longer distances, in areas of high EMI, or with 4K signal distribution.

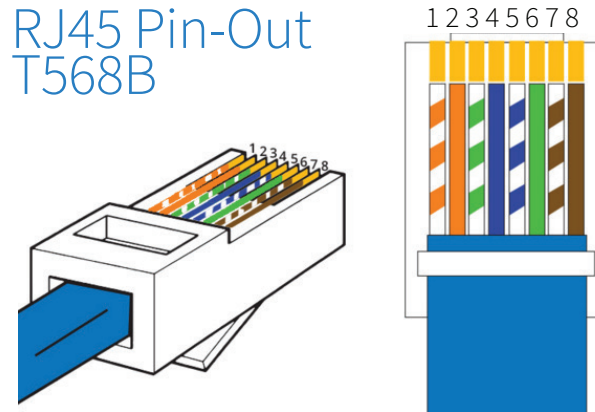

Understanding the Matrix / Receiver HDBaseT™ Status Lights

The Blustream HMXL44CS matrix and HDBaseT™ extender solutions include status LED indicators on both the matrix and receiver products to show all connections are active and to help diagnose possible problems.

Understanding The Status Lights

Blustream HMXL44CS Matrix:

- The Yellow HDBaseT™ status link light will be off when the zone output has been turned off or there is a problem with the specific matrix output
- The Yellow HDBaseT™ status link light will blink when the zone output is on and working
- The Green HDBaseT™ link light will blink if there is an unstable connection between the Blustream matrix and HDBaseT™ receiver
- The Green HDBaseT™ link light will be lit when a there is an active HDBaseT™ receiver connected to the matrix
- The Green HDBaseT™ link light will be off when a there is no connection with a HDBaseT™ receiver

Blustream HDBaseT™ Receiver:

- The HDMI link light will be off when there is no connection with a display
- The HDMI link light will be on when there is an active connection with a display (**Note:** Not all HDBaseT™ RX feature a HDMI status LED)
- The HDBaseT™ link light will be off when there is no CAT cable / active HDBaseT™ connection on the RJ45 HDBaseT™ input
- The HDBaseT™ link light will blink if there is an unstable connection between the Blustream matrix and HDBaseT™ receiver
- The HDBaseT™ link light will be lit when a CAT cable is connected to the HDBaseT™ RJ45 output on the matrix and an active connection is achieved with the Blustream HDBaseT™ receiver

Blustream Support department are on hand to assist with signal distribution issues should they arise - please email us at one of the email addresses adjacent.

Infrared (IR) Distribution

The Blustream range of matrix products include multiple options for control and routing of IR.

IMPORTANT: Blustream Infrared products are all 5V and NOT compatible with alternative manufacturers Infrared solutions. When using third party 12V IR control solutions please use supplied Blustream IRCAB cable for IR conversion.

Each Blustream matrix and HDBaseT™ receiver is supplied with all necessary IR hardware required and includes:

IR Emitter - IR1 & IR2 (IR2 sold separately)

Blustream 5V IR Emitter designed for discrete IR control of hardware

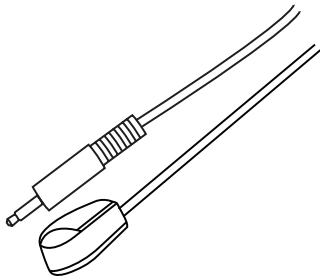

Infrared 3.5mm Pin-Out

IR Emitter - Mono 3.5mm

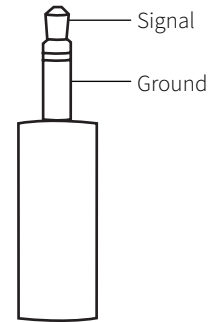

IR Receiver - IRR

Blustream 5V IR receiver to receive IR signal and distribute through Blustream products

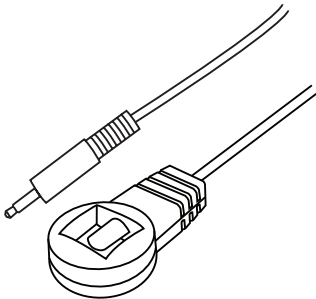

IR Receiver - Stereo 3.5mm

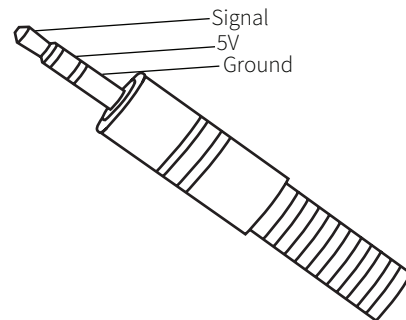

IR Control Cable - IRCAB

Blustream IR Control cable 3.5mm Mono to 3.5mm Stereo for linking third party control solutions to Blustream products.

Compatible with 12v IR third party products.

Note: Cable is directional as indicated

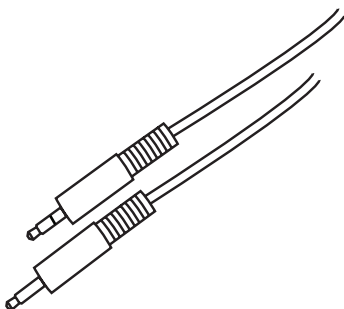

Remote Control Description

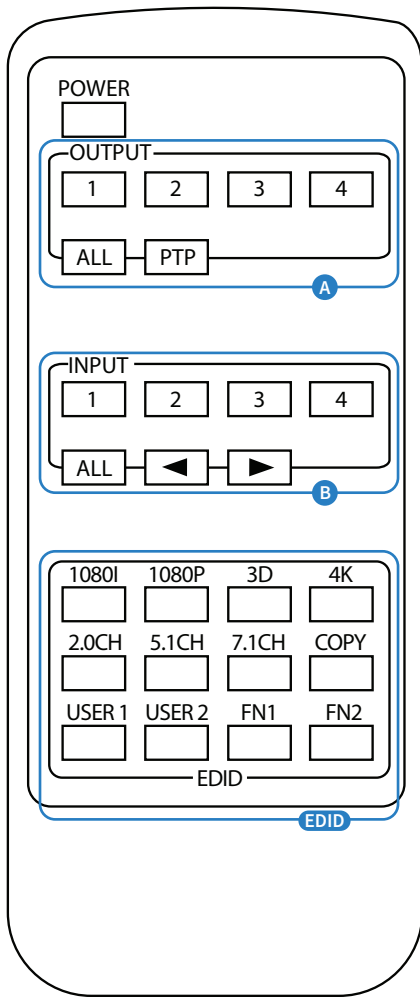

OUTPUT AND INPUT SELECTION

- A** Selects the zone OUTPUT you wish to change the source on (Numbers 1 - 4 correspond to the zone outputs 1 - 4)
- B** Selects the source INPUT you wish to change on the selected zone (Numbers 1 - 4 correspond to the source inputs 1 - 4)

EXAMPLE

To switch source 2 to zone 4 you would press 4 in the output section (A) followed by pressing 2 in the Input section (B).

ALL button: The all button selects all the inputs or outputs in its corresponding box. Example: (The "All" button in the Output box selects all the zones so all zones will change to what source input is selected next)

PTP: This button will align all the zone outputs with the like numbered source inputs. Example: Input 1 to output 1, input 2 to output 2, etc

EDID SET UP

The HMXL44CS provides a comprehensive range of EDID settings. Below are three examples of how to deploy the desired EDID setting when using the supplied remote.

- A. Fix EDID to an Input or ALL inputs:** Press the desired video resolution button (1080I / 1080P / 3D / 4K), then select the desired audio format (2.0CH / 5.1CH / 7.1CH), then select the source input you want this EDID information allocated to by pressing the INPUT 1 – 4 or the ALL button
- B. Copy EDID of Output-X to an Input or ALL:** Press the COPY button then select the OUTPUT you wish to copy the EDID information from, then select the source input you want to copy this EDID to by selecting the INPUT 1-4 or the ALL button.
- C. User defined EDID to an Input or ALL inputs:** Press USER1 / USER2 button then select the source you wish to assign this EDID to by select-ing INPUT 1-4 or the ALL button

Note: THE BUTTON PRESS SEQUENCE SHOULD BE FINISHED IN 3 SECONDS, OTHERWISE THE OPERATION IS DISCARDED

EDID Control

EDID (Extended Display Identification Data) is a data structure that is used between a display and a source. This data is used by the source to find out what audio and video resolutions are supported by the display then from this information the source will discover what the best audio and video resolutions need to be outputted.

While the objective of EDID is to make connecting a digital display to a source a simple plug and play procedure issues do arise when multiple displays or video matrix switching is introduced because of the increased number of variables.

By pre-determining the video resolution and audio format of the source and display device you can reduce the time need for EDID hand shaking thus making switching quicker and more reliable.

Configuration of Matrix EDID settings can be acheived in one of five ways:

- 1 Using Matrix PC Software (see ‘Blustream Matrix Software Guide’ for further details see the Blustream website)
 - 2 Using Matrix web browser interface (see ‘Blustream Web Browser Interface Guide’ for further details see the Blustream website)
 - 3 Using Matrix Front Panel Buttons (for further details see page 8)
 - 4 Using supplied Blustream Matrix IR Remote Control (for further details see page 12)
 - 5 Using dip-switches on the rear panel of the HMXL44CS Matrix. Please see below table for global EDID settings.
- Note:** once dip-switch settings have been changed the HMXL44CS should be power cycled for settings to be applied.

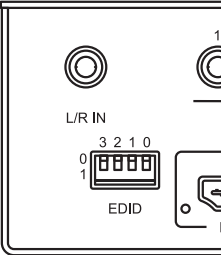

Dip-switch Position '0' = Off
Dip-switch Position '1' = On

Global EDID Settings

DIP ON ▼/OFF▲ SWITCHING POSITIONS				
3	2	1	0	EDID TYPE
OFF	OFF	OFF	OFF	1080p/2.0ch
OFF	OFF	OFF	ON	1080p/5.1ch
OFF	OFF	ON	OFF	1080p/7.1ch
OFF	OFF	ON	ON	1080i/2.0ch
OFF	ON	OFF	OFF	1080i/5.1ch
OFF	ON	OFF	ON	1080i/7.1ch
OFF	ON	ON	OFF	4K60Hz 4:2:0/2.0ch
OFF	ON	ON	ON	4K60Hz 4:2:0/5.1ch
ON	OFF	OFF	OFF	4K60Hz 4:2:0/7.1ch
ON	OFF	OFF	ON	4K60Hz 4:4:4/2.0ch
ON	OFF	ON	OFF	4K60Hz 4:4:4/5.1ch
ON	OFF	ON	ON	4K60Hz 4:4:4/7.1ch
ON	ON	OFF	OFF	DVI 1280x1024
ON	ON	OFF	ON	DVI 1920x1080
ON	ON	ON	OFF	DVI 1920x1200
ON	ON	ON	ON	Software Controlled EDID

To manage EDID using the App or Web GUI, it is necessary to select the appropriate DIP switch selection on the Matrix. Until the Matrix EDID DIP switches have been assigned to ‘Software Controlled EDID’, the option to select individual EDID’s per input will remain greyed out within the software.

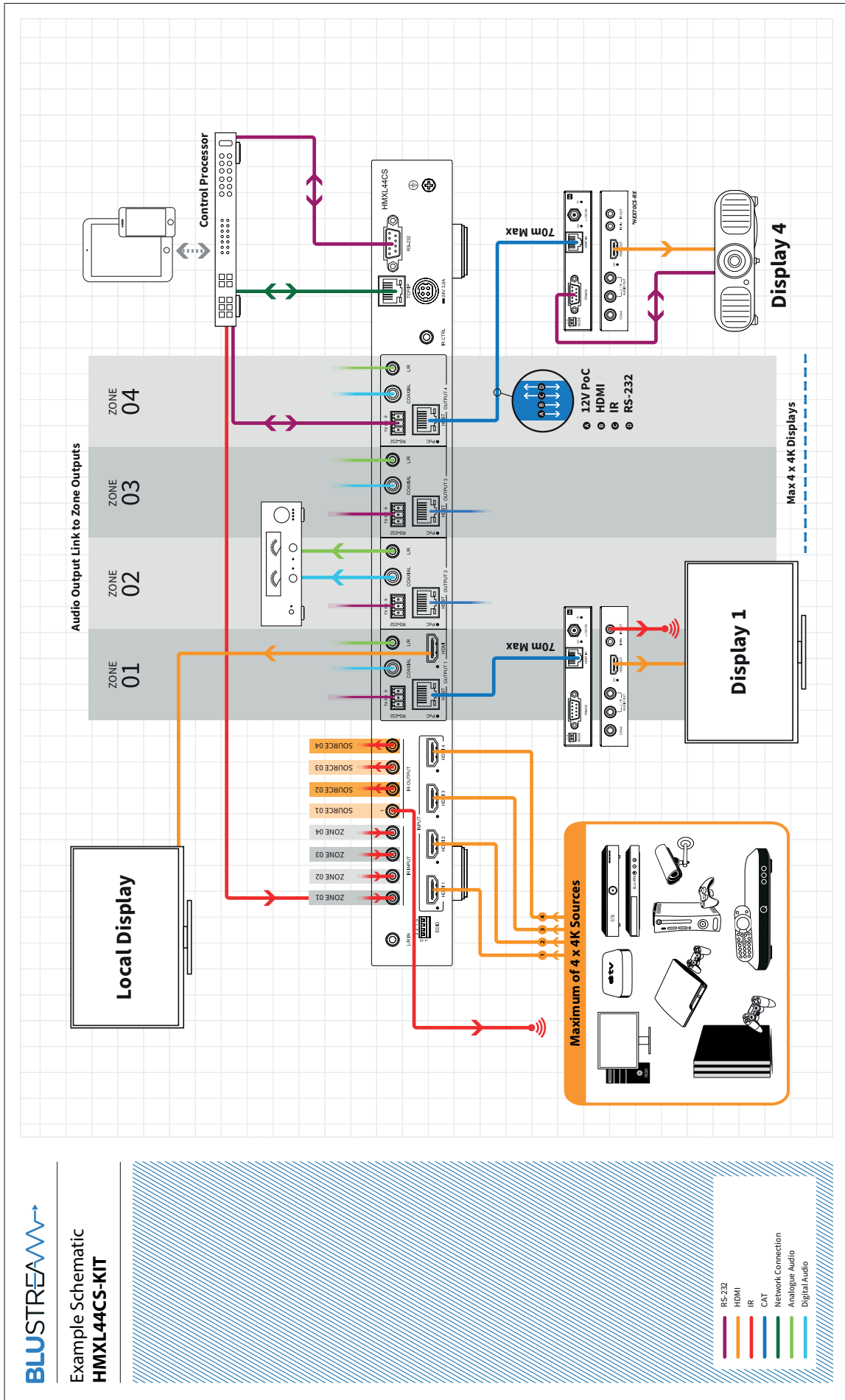

Web GUI Control

The HMXL44CS-KIT features an in-built Web GUI which can be used for control and configuration of the matrix. By default the matrix is set to DHCP, however if a DHCP server (eg: network router) is not installed the matrix IP address will revert to below details:

Default **Username** is: [blustream](#)

Default **Password** is: [1234](#)

Default **IP Address** is: [192.168.0.200](#)

Specifications

Video Input Connectors: 4 x HDMI Type A, 19-pin, female, locking

Video Output Connectors: 1 x HDMI Type A, 4 x HDBaseT™ RJ45 connector

Audio Input Connectors: 1 x 3.5mm stereo jack (L/R)

Audio Output Connectors: 4 x RCA (S/PDIF), 4 x 3.5mm stereo jack (L/R)

RS-232 Serial Port: 1 x DB 9 connector (control), 4 x 3-pin Phoenix (pass-through)

TCP/IP Control: 1 x RJ45, female

IR Input Ports: 5 x 3.5mm stereo jack

IR Output Ports: 4 x 3.5mm mono jack

Dimensions (W x H x D): 440mm x 245mm x 52mm

Case Dimensions (W x H x D): 440mm x 235mm x 44mm

Shipping Weight: 2.7Kg

Operating Temperature: 32°F to 104°F (0°C to 40°C)

Storage Temperature: -4°F to 140°F (-20°C to 60°C)

Power Supply: 1 x 24V DC/3.5A

Note: Specifications are subject to change without notice.

Package Contents

- 1 x HMXL44CS Matrix
- 4 x HEX70CS-RX Receivers
- 1 x 19" Rack Mounting Kit
- 4 x Mounting Kits for HEX70CS-RX
- 1 x 24V/3.5A Power Supply
- 1 x Remote Control
- 5 x IRR Blustream 5V IR Receivers
- 4 x IRE1 Blustream 5V IR Emitters
- 4 x IR-CAB IR Control Cable - 12V to 5V IR Cable
- 1 x Quick Reference Guide

Maintenance

Clean this unit with a soft, dry cloth. Never use alcohol, paint thinner or benzene to clean this unit.

For the full Blustream HMXL44CS-KIT User Manual please visit the product page on the Blustream website.

Certifications

FCC NOTICE

This equipment has been tested and found to comply with the limits for a Class B digital device, pursuant to part 15 of the FCC Rules. These limits are designed to provide reasonable protection against harmful interference in a residential installation. This equipment generates, uses, and can radiate radio frequency energy and, if not installed and used in accordance with the instructions,

may cause harmful interference to radio communications. However, there is no guarantee that interference will not occur in a particular installation. If this equipment does cause harmful interference to radio or television reception, which can be determined by

turning the equipment off and on, the user is encouraged to try to correct the interference by one or more of the following measures:

- Reorient or relocate the receiving antenna.
- Increase the separation between the equipment and receiver.
- Connect the equipment into an outlet on a circuit different from that to which the receiver is connected.
- Consult the dealer or an experienced radio/TV technician for help.

CAUTION - changes or modifications not expressly approved by the party responsible for compliance could void the user's authority to operate the equipment.

CANADA, INDUSTRY CANADA (IC) NOTICES

This Class B digital apparatus complies with Canadian ICES-003. Operation is subject to the following two conditions: (1) this device may not cause interference, and (2) this device must accept any interference, including interference that may cause undesired operation of the device.

CORRECT DISPOSAL OF THIS PRODUCT

This marking indicates that this product should not be disposed with other household wastes. To prevent possible harm to the environment or human health from uncontrolled waste disposal, recycle it responsibly to promote the sustainable reuse of material resources. To return your used device, please use the return and collection systems or contact the retailer where the product was purchased. They can take this product for environmentally safe recycling.

RS-232 and Telnet Commands

The Blustream HMXL44CS can be controlled via serial and TCP/IP. The following pages list all available serial commands for the HMXL44CS matrix. Details of RS-232 pin assignment can be found on page 05.

Commonly used Serial commands:

There are several commands that are commonly used for control and testing:-

STATUS	Status will give feedback on Matrix such as zones on, type of connection etc
PON	Power on
POFF	Power off
OUTxxON	(xx is the zone number you wish to turn on)
Example:-	OUT01ON (This would turn output one back on)
OUTxxFRyy	(xx is the zone out, yy is the input)
Example:-	OUT01FR04 (This would switch output 1 to source input 4)

Common Mistakes

- Carriage Return – Some programs do not require the carriage return where as other will not work unless sent directly after the string. In the case of some Terminal software the token <CR> is used to execute a carriage return. Depending on the program you are using this token maybe different. Some other examples that other control systems deploy include \r or 0D (in hex)
- Spaces – Blustream commands do not require space between commands unless specified. There may be some programs that require spacing in order to work.
 - How the string should look is as follows OUT01ON
 - How the string may look if spaces are required: OUT{Space}01{Space}ON
- Baud rate or other serial protocol settings not correct - please see Page 6 for Matrix settings

RS232 Command	Description
?	Print Help Information
HELP	Print Help Information
STATUS	Print System Status And Port Status
PON	Power On, System Run On Normal State
POFF	Power Off, System Run On Power Save State
IRON/OFF	Set System IR Control On Or Off
KEYON/OFF	Set System KEY Control On Or Off
DBG ON/OFF	Set Debug Mode On Or Off
BEEPON/OFF	Set Onboard Beep On Or Off
RESET	Reset System To Default Setting (Should Type "Yes" To Confirm, "No" To Discard)
OUTxxON/OFF	Set OUTPUT:xx On Or Off
POHxxON/OFF	Set POH OUTPUT:xx On Or Off (xx = 01 to 04 or 'ALL' for all outputs)

RS232 and Telnet Commands (Continued)

RS232 Command	Description
OUTxxFRyy	Set OUTPUT:xx From INPUT:yy
EDIDxxCPyy	Copy EDID from output (yy) to input (xx) Both yy & xx can be set individually (01-08) or as ALL (00) Set Input:xx EDID To Default EDID:zz xx=00: Select All INPUT Port xx=[01...04]: Select One INPUT Port yy=[01...02]: Select One OUTPUT Port zz=00: HDMI 1080p@60Hz, Audio 2CH PCM zz=01: HDMI 1080p@60Hz, Audio 5.1CH PCM/DTS/DOLBY zz=02: HDMI 1080p@60Hz, Audio 7.1CH PCM/DTS/DOLBY/HD zz=03: HDMI 1080i@60Hz, Audio 2CH PCM zz=04: HDMI 1080i@60Hz, Audio 5.1CH PCM/DTS/DOLBY zz=05: HDMI 1080i@60Hz, Audio 7.1CH PCM/DTS/DOLBY/HD zz=06: HDMI 1080p@60Hz/3D, Audio 2CH PCM zz=07: HDMI 1080p@60Hz/3D, Audio 5.1CH PCM/DTS/DOLBY zz=08: HDMI 1080p@60Hz/3D, Audio 7.1CH PCM/DTS/DOLBY/HD zz=09: HDMI 4K2K, Audio 2CH PCM zz=10: HDMI 4K2K, Audio 5.1CH PCM/DTS/DOLBY zz=11: HDMI 4K2K, Audio 7.1CH PCM/DTS/DOLBY/HD zz=12: DVI 1280x1024@60Hz, Audio None zz=13: DVI 1920x1080@60Hz, Audio None zz=14: DVI 1920x1200@60Hz, Audio None
EDIDxxDFzz	
MUTEmmTXyy	Turn MUTE (mm = ON or OFF) on OUTPUT (yy = 01 to 04 or 00 for all outputs)
VOLxxTXyy	Set VOLUME level:xx on OUTPUT:yy xx = 00...30: Set volume levels xx = +: Volume level increases xx = -: Volume level decreases yy = 00: Select ALL output ports xx = 01 to 04: Select single output port
RESETDEF	Restore factory settings

Blustream Web Browser Interface

The Blustream HMXL44CS-KIT matrix unit can be both controlled and configured using the in-built web-server.

The HMXL44CS-KIT Matrix must be connected to an active network router/switch and it is advised that the Matrix is given a static IP address. You can configure the network settings of the Matrix using either the Web Browser Interface (Blustream Matrix products are shipped with the network set to DHCP) or using the Blustream PC Configuration Software (downloadable from the Blustream Drivers & Protocols link on the product web page).

For detailed instructions on using the Blustream Web Browser Interface please download the specific software manual from the Blustream website.



www.blustream-us.com
www.blustream.com.au
www.blustream.co.uk