

TeamConnect Wireless Set Tray

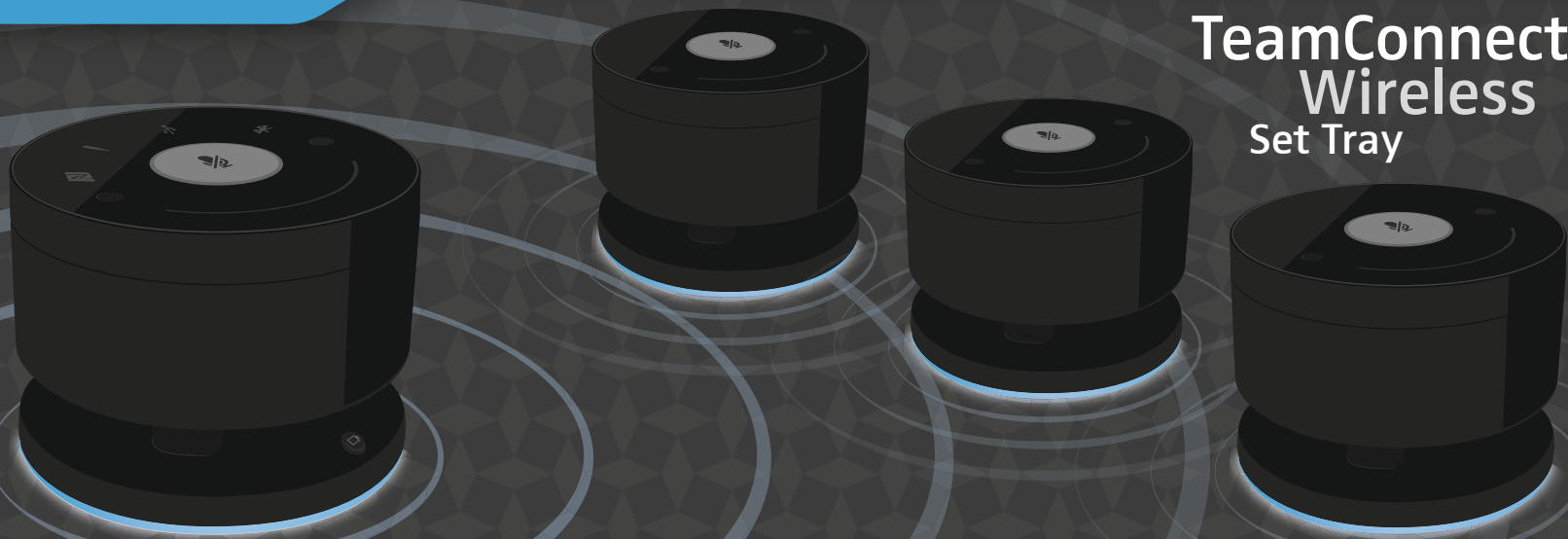

User Guide | Bedienungsanleitung | Notice d'emploi | Instrucciones de uso |
Manual de instruções | Istruzioni per l'uso | Gebruiksaanwijzing |
Οδηγίες λειτουργίας | 取扱説明書



1 Scope of delivery

Lieferumfang | Contenu | Volumen de suministro | Material fornecido | Συσκευασία παράδοσης | Dotazione | Omvang levering | 同梱されているもの

2 Preparing for use

Verwendung vorbereiten | Préparer l'utilisation | Preparación para el uso | Preparar utilização | Προετοιμασία χρήσης | Preparazione all'utilizzo | Het gebruik voorbereiden | 使用準備

3 Setting up

System einrichten | Configurer le système | Configurar el sistema | Configurar o sistema | Προετοιμασία συστήματος | Configurazione del sistema | Het systeem instellen
システムセットアップ

4 Connecting devices

Geräte verbinden | Raccorder les appareils | Conectar dispositivos | Ligar o aparelho | Σύνδεση συσκευών | Collegamento dei dispositivi | De apparaten met elkaar verbinden
装置を接続する

5 Using the product

Produkt verwenden | Utiliser le produit | Utilizar el producto | Utilizar o produto | Χρησιμοποίηση προϊόντος | Utilizzo del prodotto | Het product gebruiken
製品を使用する

6 Charging

Akkus laden | Charger les batteries | Cargar las pilas recargables | Carregar as pilhas recarregáveis | Φόρτιση μπαταριών | Caricamento delle batterie | Accu's opladen | バッテリーを充電する

7 Cleaning and maintenance

Produkt reinigen und pflegen | Nettoyer et entretenir le produit | Limpieza y cuidado del producto | Limpar e conservar o produto | Καθαρισμός και φροντίδα προϊόντος | Pulizia e manutenzione del prodotto | Het product schoonmaken en onderhouden
製品を清掃する/手入れする

1 Scope of delivery

Scope of delivery

Lieferumfang

Contenu

Volumen de suministro

Material fornecido

Συσκευασία παράδοσης

Dotazione

Omvang levering

同梱されているもの

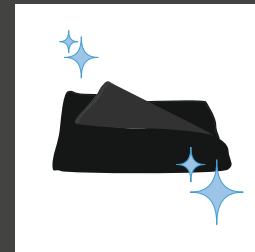
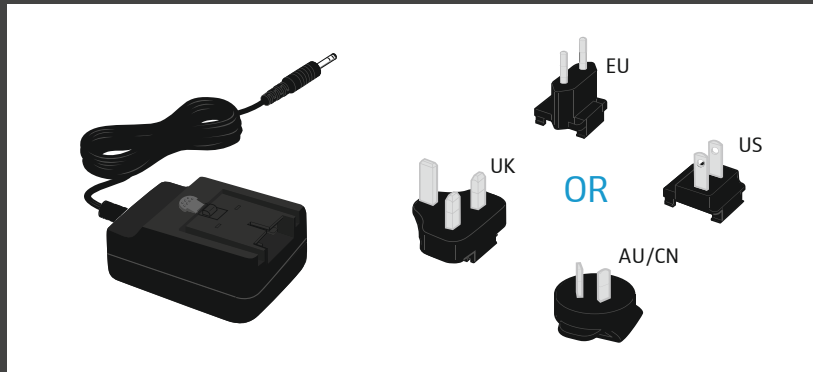
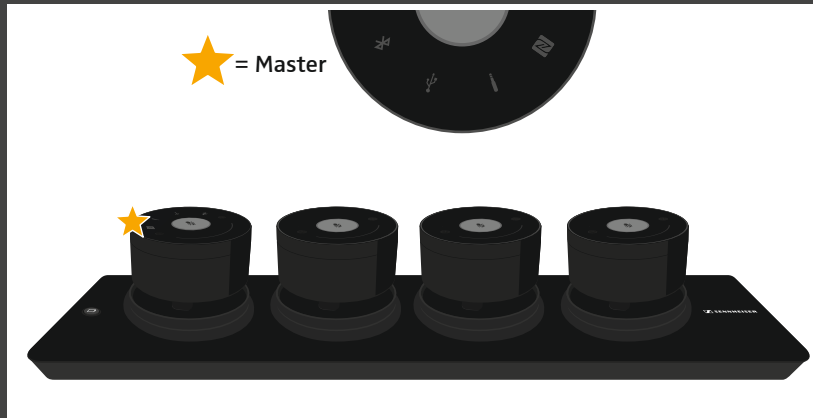

2 Preparing for use

Removing protective covers

Schutzfolien entfernen

Enlever les feuilles de protection

Retirar las láminas protectoras

Retirar a película de proteção

Αφαίρεση προστατευτικών μεμβρανών

Rimozione della pellicola protettiva

De beschermingsfolie verwijderen

保護ファイルを取り除く

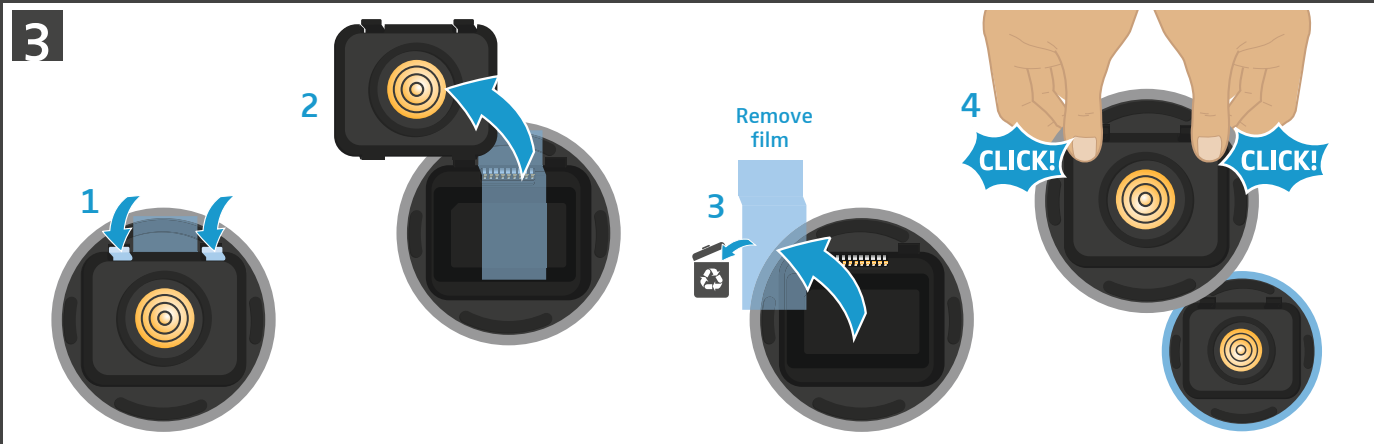
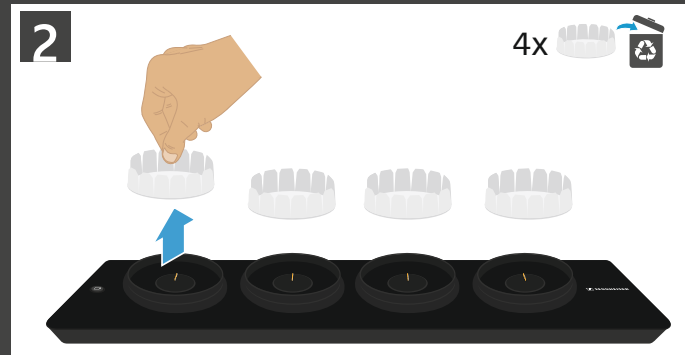
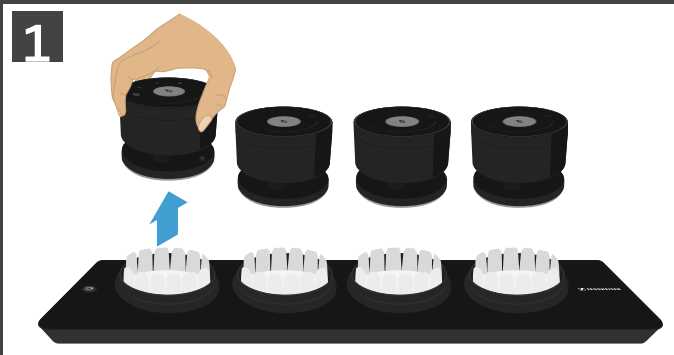

2 Preparing for use

Initial charging

Erstes Mal laden

Charger les satellites pour la première fois

Cargar por primera vez

Realizar o primeiro carregamento

Φόρτιση πρώτη φορά

Primo caricamento

De eerste keer opladen

初回充電

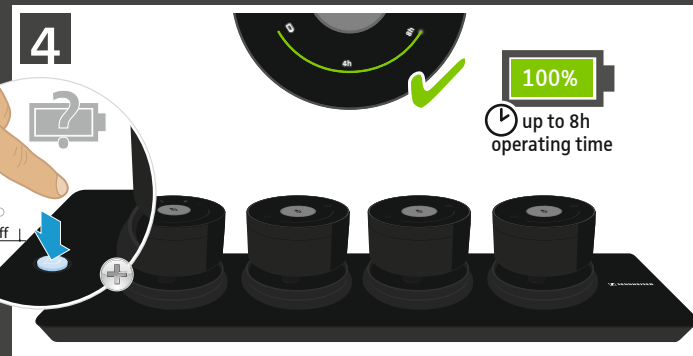
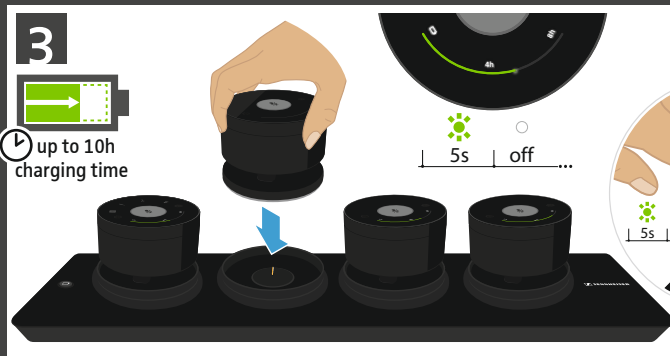
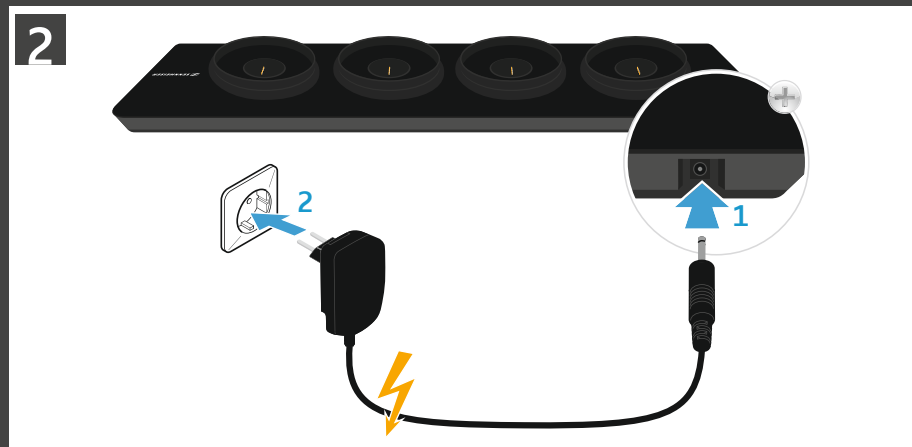
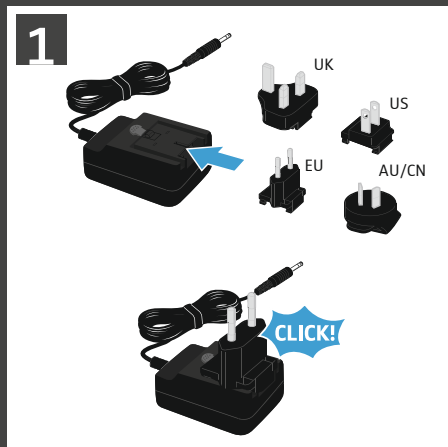

3 Setting up

Activating the satellites

Satelliten aktivieren

Activer les satellites

Activar satélites

Ativar os satélites

Ενεργοποίηση δορυφόρων

Attivazione satellite

De satellieten activeren

サテライト装置を有効にする

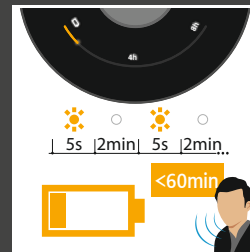
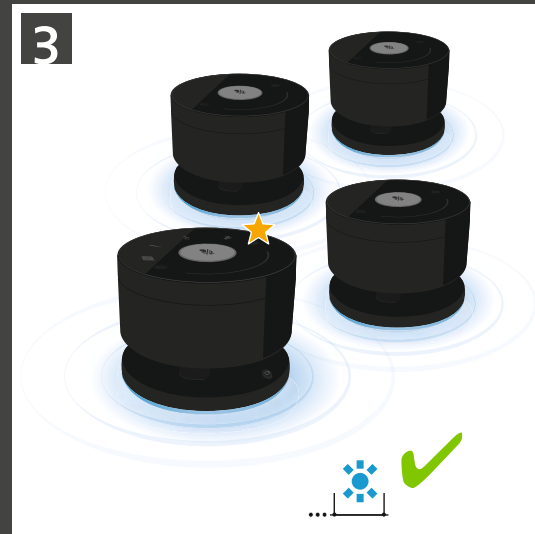
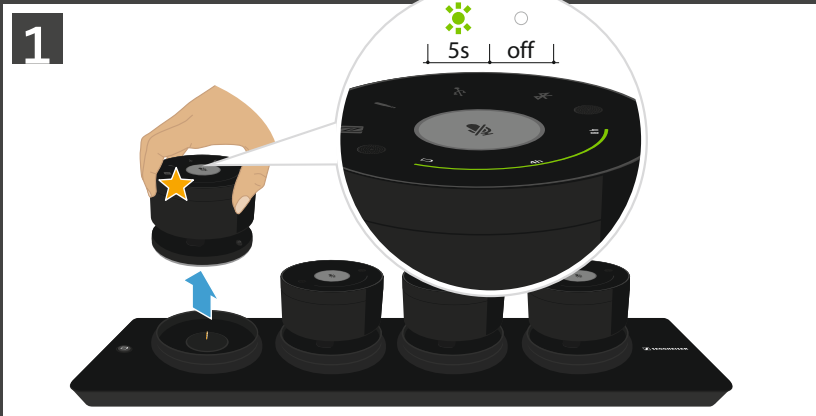

4 Connecting devices

Connections overview

Übersicht der Anschlüsse

Vue d'ensemble des connexions

Vista general de las conexiones

Vista geral das ligações

Επισκόπηση των συνδέσεων

Panoramica dei collegamenti

Overzicht van de aansluitingen

接続ポートの概要

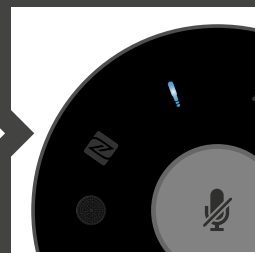
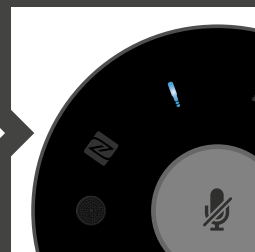
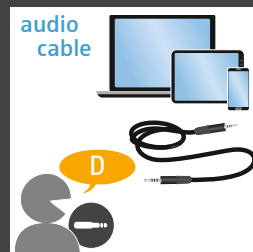
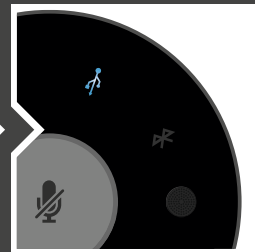
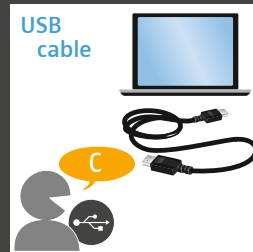
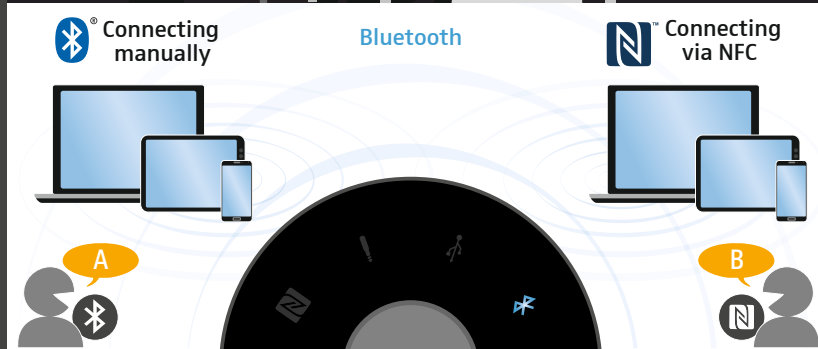

4 Connecting devices

Connecting via Bluetooth

Bluetooth-Verbindung herstellen

Établir la connexion Bluetooth

Establecer conexión Bluetooth

Estabelecer a ligação Bluetooth

Δημιουργία σύνδεσης Bluetooth

Creazione connessione bluetooth

De Bluetooth-verbinding tot stand brengen

Bluetooth接続を確立する



1 Activate Bluetooth on your device



2 Activate Bluetooth & pairing mode

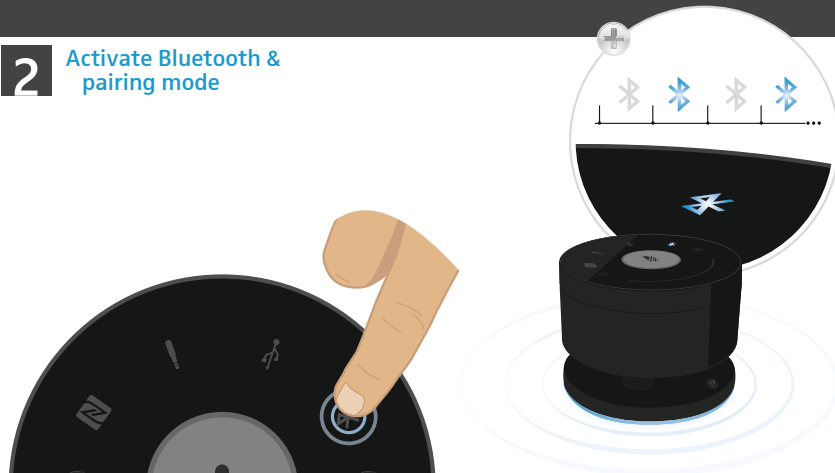

3 Pairing: Search Bluetooth devices and select "TC-W xxxxxxxx"



4

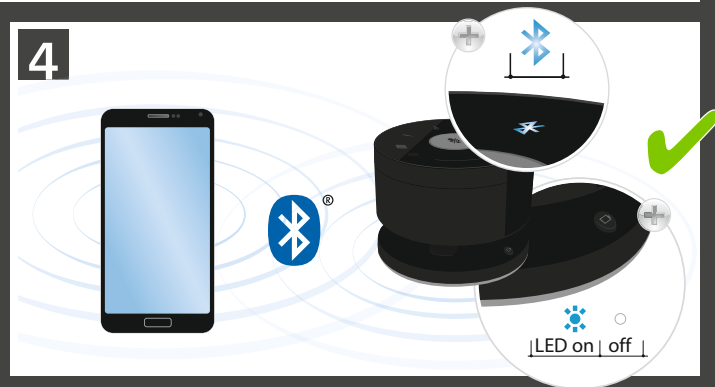

1

2

3

4

5

6

7

4 Connecting devices

- Connecting Bluetooth via NFC
- Bluetooth via NFC verbinden
- Connecter Bluetooth via NFC
- Conectar Bluetooth vía NFC
- Ligar Bluetooth via NFC
- Σύνδεση Bluetooth μέσω NFC
- Connessione bluetooth tramite NFC
- Bluetooth via NFC verbinden
- BluetoothをNFC機能を使用してペアリング



1 Activate Bluetooth & NFC (Near field communication) on your device

2 Hold close to activate Master's ★ Bluetooth function

3 In pairing mode

4

4 Connecting devices

Saving one priority Bluetooth device

Ein vorrangiges Bluetooth-Gerät speichern

Enregistrer un périphérique Bluetooth prioritaire

Guardar un dispositivo Bluetooth prioritario

Guardar um dispositivo Bluetooth prioritário

Αποθήκευση μιας συσκευής Bluetooth σε προτεραιότητα

Salvataggio di un dispositivo Bluetooth prioritario

Een preferentieel Bluetooth-toestel opslaan

当面のBluetooth デバイスを保存する

1 Activate priority device Bluetooth pairing mode

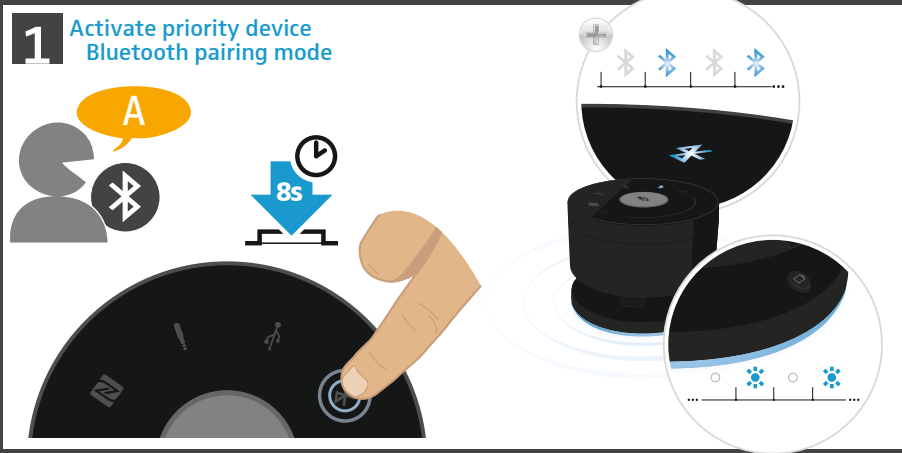

2 Pairing priority device: Search Bluetooth devices and select "TC-W xxxxxxxx"



3 Saves & connects priority device

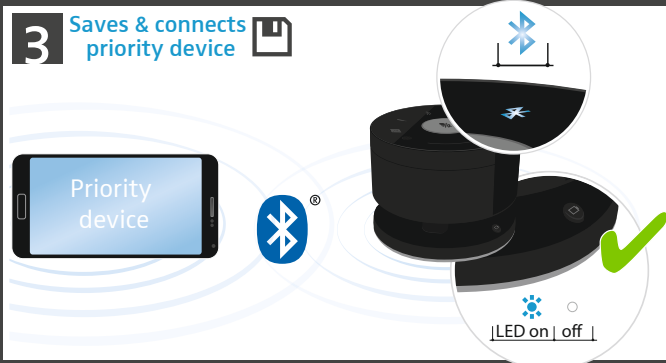

4 Delete priority device

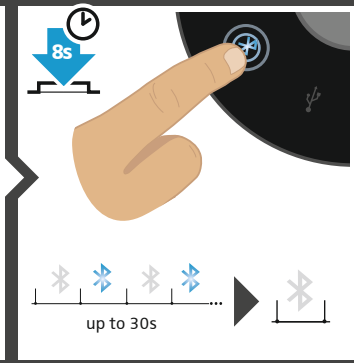
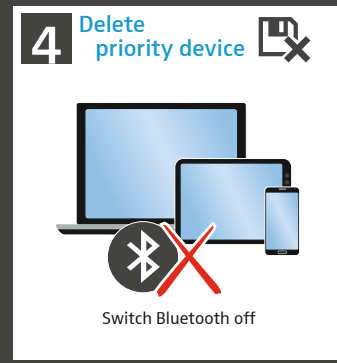

4 Connecting devices

Working with priority Bluetooth device

Mit vorrangigem Bluetooth-Gerät arbeiten

Travailler avec un périphérique Bluetooth prioritaire

Trabajar con un dispositivo Bluetooth prioritario

Utilizar o dispositivo Bluetooth prioritário

Εργασία με μια συσκευή Bluetooth σε προτεραιότητα

Utilizzo del dispositivo Bluetooth prioritario

Met een preferentieel Bluetooth-toestel werken

優先のBluetooth デバイスを保存する

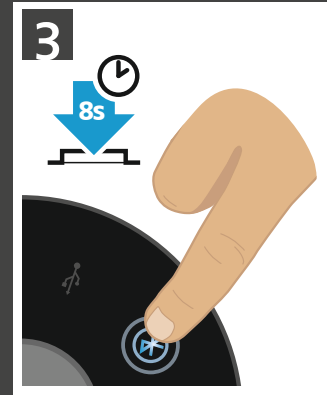
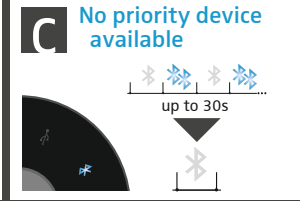
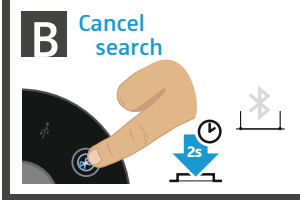
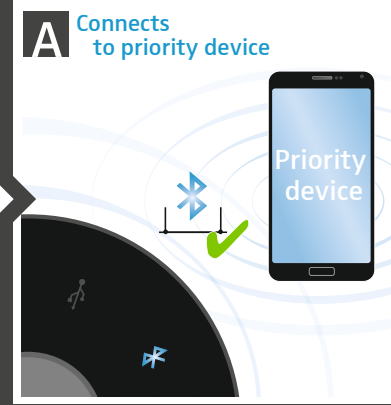
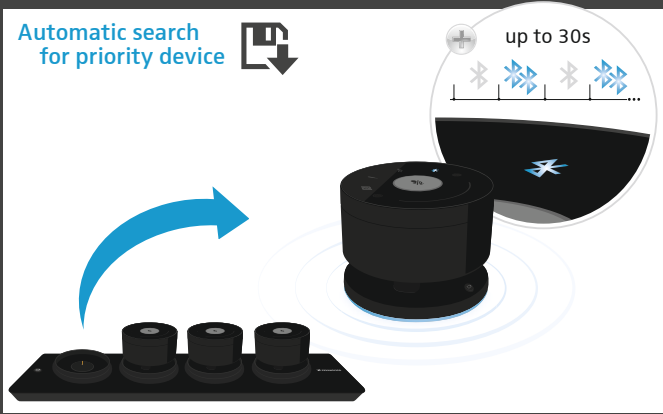

4 Connecting devices

Connecting via USB cable

USB-Kabel anschließen

Connecter le cable USB

Conectar el cable USB

Ligar o cabo USB

Σύνδεση καλωδίου USB

Collegamento del cavo USB

DE USB-kabel aansluiten

USBケーブルを接続する

1 Connect the USB cable



2



3

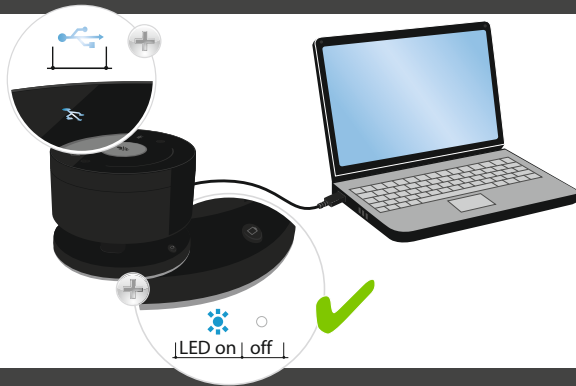

4

1st use: New audio device will be installed



4 Connecting devices

Connecting via audio cable

Audiokabel anschließen

Connecter le cable audio

Conectar el cable de audio

Ligar o cabo áudio

Σύνδεση καλωδίου ήχου

Collegamento
del cavo audio

De audiokabel aansluiten

オーディオケーブルを接続する

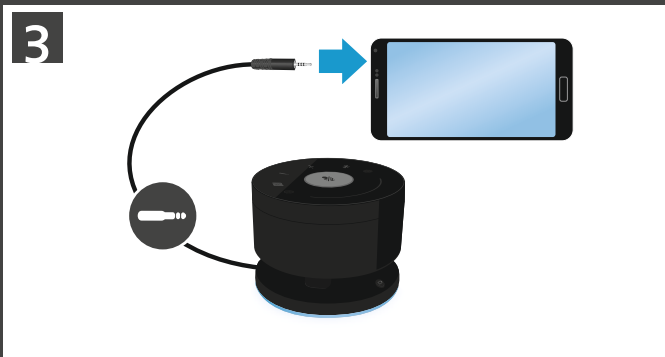
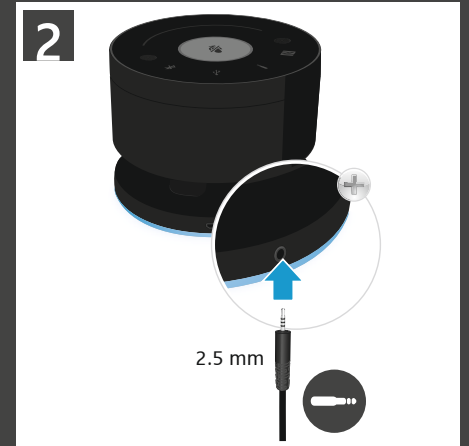
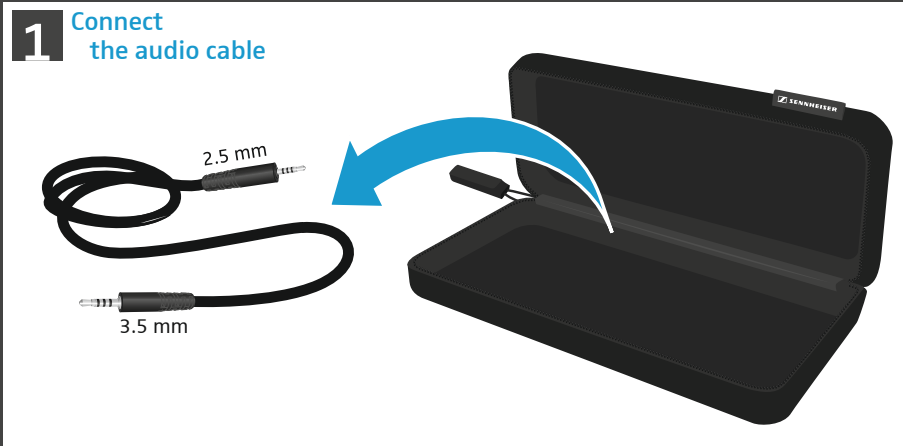

4 Connecting devices

Connecting via optional telephone cable*

Optionales Telefonkabel* anschließen

Raccorder un câble de téléphone* optionnel

Conectar un cable de teléfono* opcional

Ligar o cabo telefónico opcional*

Σύνδεση προαιρετικού τηλεφωνικού καλωδίου*

Collegamento cavo del telefono opzionale*

De als optie verkrijgbare telefoonkabel* aansluiten

オプションの電話線*を接続する

E



1 Connect the Sennheiser telephone adapter cable

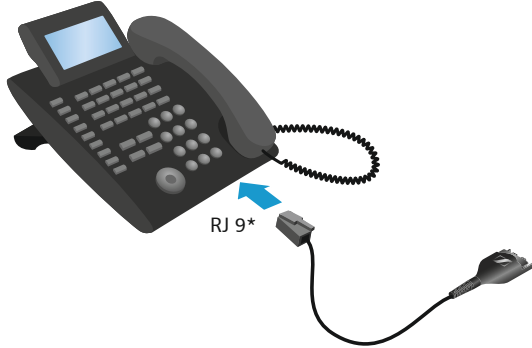

Accessories*



TC-W telephone cable



Sennheiser telephone adapter cable* phone dependent



*cable support: www.sennheiser.com/telephone-headset-compatibility

2

Connect the TC-W telephone cable



3 Connect the plugs

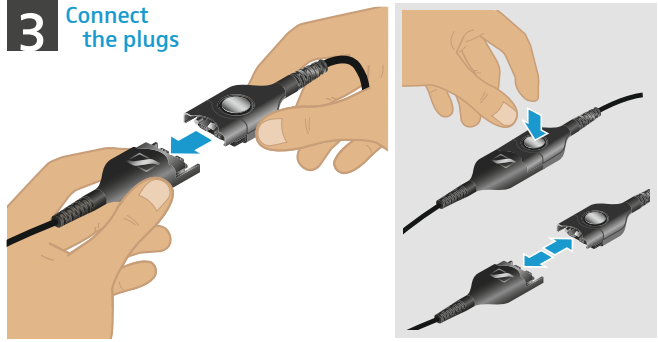

4



5 Using the product

Changing the satellites' volume

Lautstärke der Satelliten einstellen

Régler le volume sonore des satellites

Ajustar el volumen de los satélites

Ajustar os volumes dos satélites

Ρύθμιση της έντασης ήχου των δορυφόρων

Impostazione del volume dei satelliti

Het volume van de satellieten instellen

サテライト装置の通話音量を調節する

1 The default volume of all satellites is set to medium

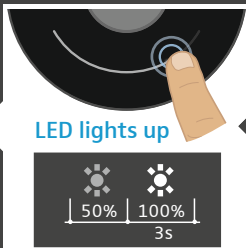
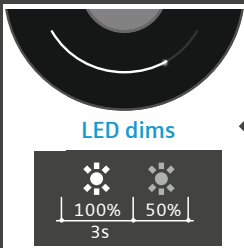
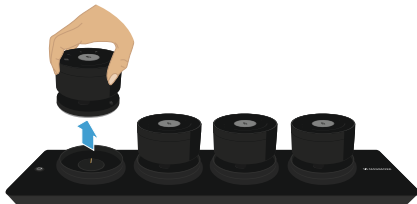

2 Change the volume for each satellite

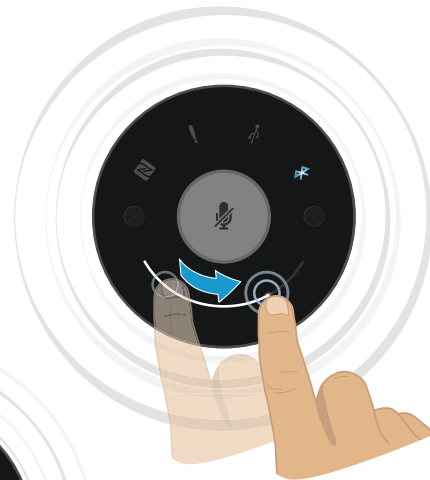

5 Using the product

Muting all microphones

Alle Mikrofone
stummschalten

Couper tous les
microphones

Silenciar todos
los micrófonos

Colocar todos os
microfones em silêncio

Σίγαση όλων των
μικροφώνων

Silenziamento di
tutti microfoni

Alle microfoons
op mute schakelen

すべてのマイクをミュートする

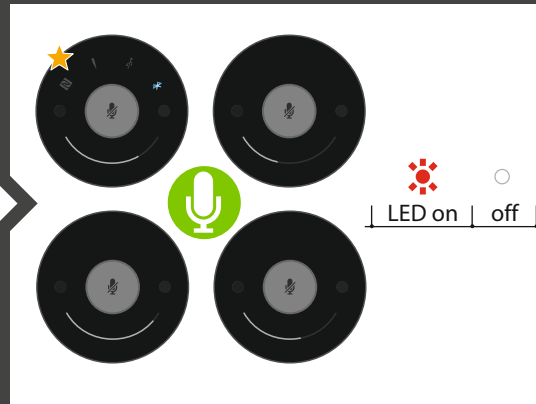
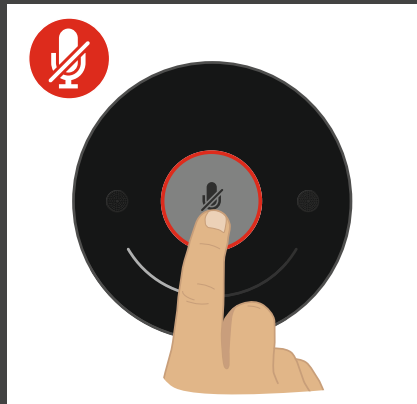
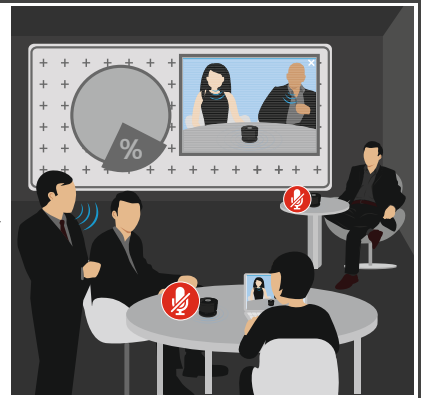
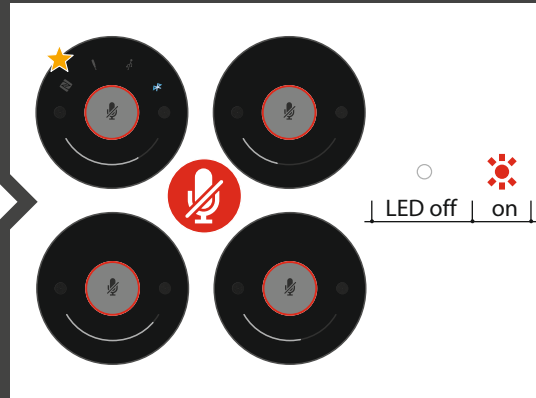
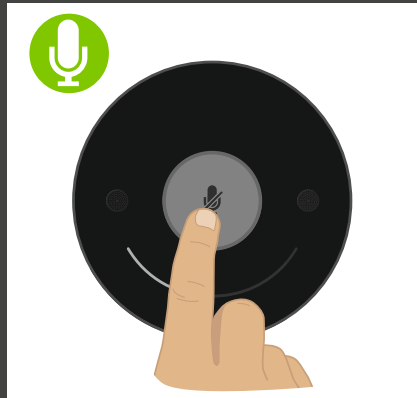

5 Using the product

Muting the microphones separately

Mikrofone einzeln stummschalten

Couper les microphones individuellement

Silenciar micrófonos individualmente

Colocar um microfone individual em silêncio

Σίγαση μικροφώνων ξεχωριστά

Silenziamento di microfoni singoli

Microfoons afzonderlijk op mute schakelen

マイクを個別にミュートする

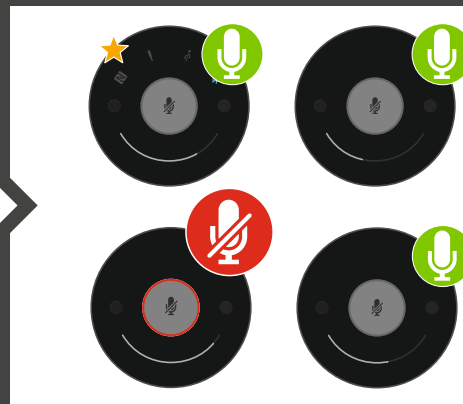
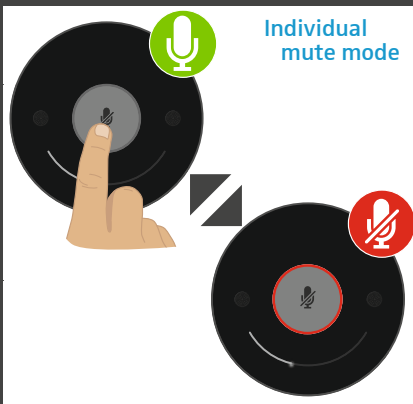
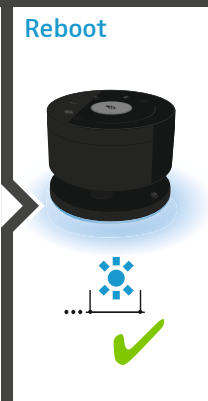
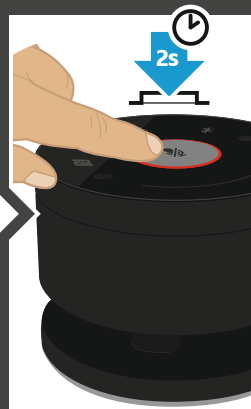
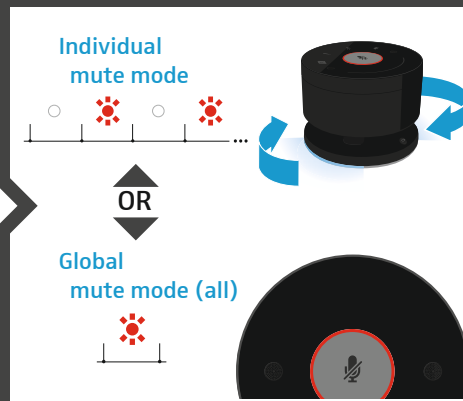

5 Using the product

Setting up a remote conference

Web- oder Telekonferenz durchführen

Effectuer une conférence web ou une téléconférence

Realizar una conferencia web o telefónica

Realizar conferência telefónica ou online

Πραγματοποίηση διαδικτυακής ή τηλεφωνικής συνδιάσκεψης

Eseguire conferenze Web o teleconferenze

Web- of telefonische conferentie uitvoeren

ウェブ会議または電話会議を行う

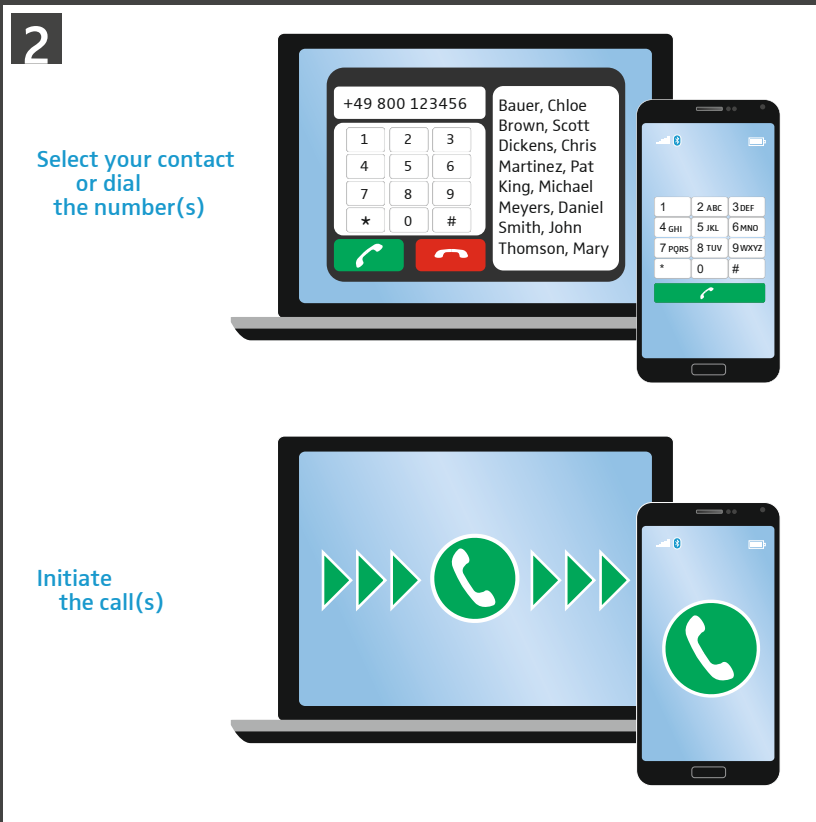
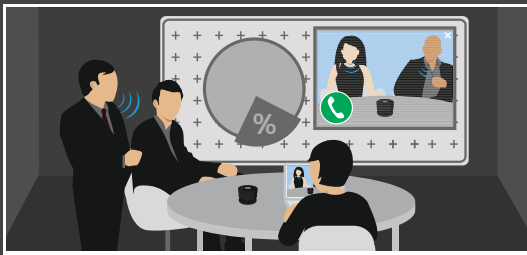
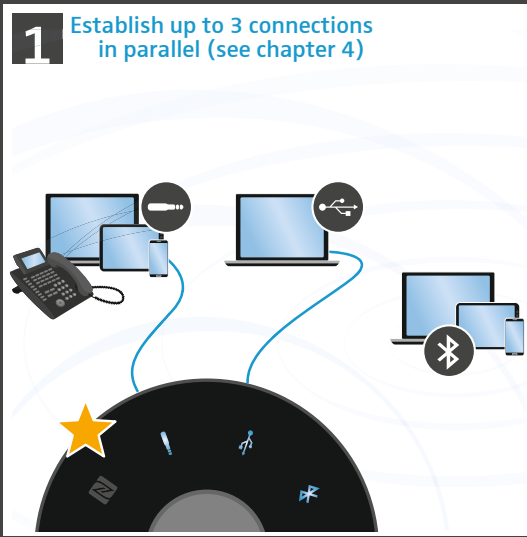

5 Using the product

Managing calls

Anrufe annehmen/
ablehnen/beenden

Prendre/rejeter/
terminer des appels

Contestar/rechazar/
finalizar llamadas

Atender/recusar/
terminar chamada

Αποδοχή/απόρριψη/
τερματισμός κλήσεων

Accettare/rifiutare/
terminare chiamate

Gesprekken aannemen/
weigeren/beëindigen

通話を受ける/拒否する/
終了する

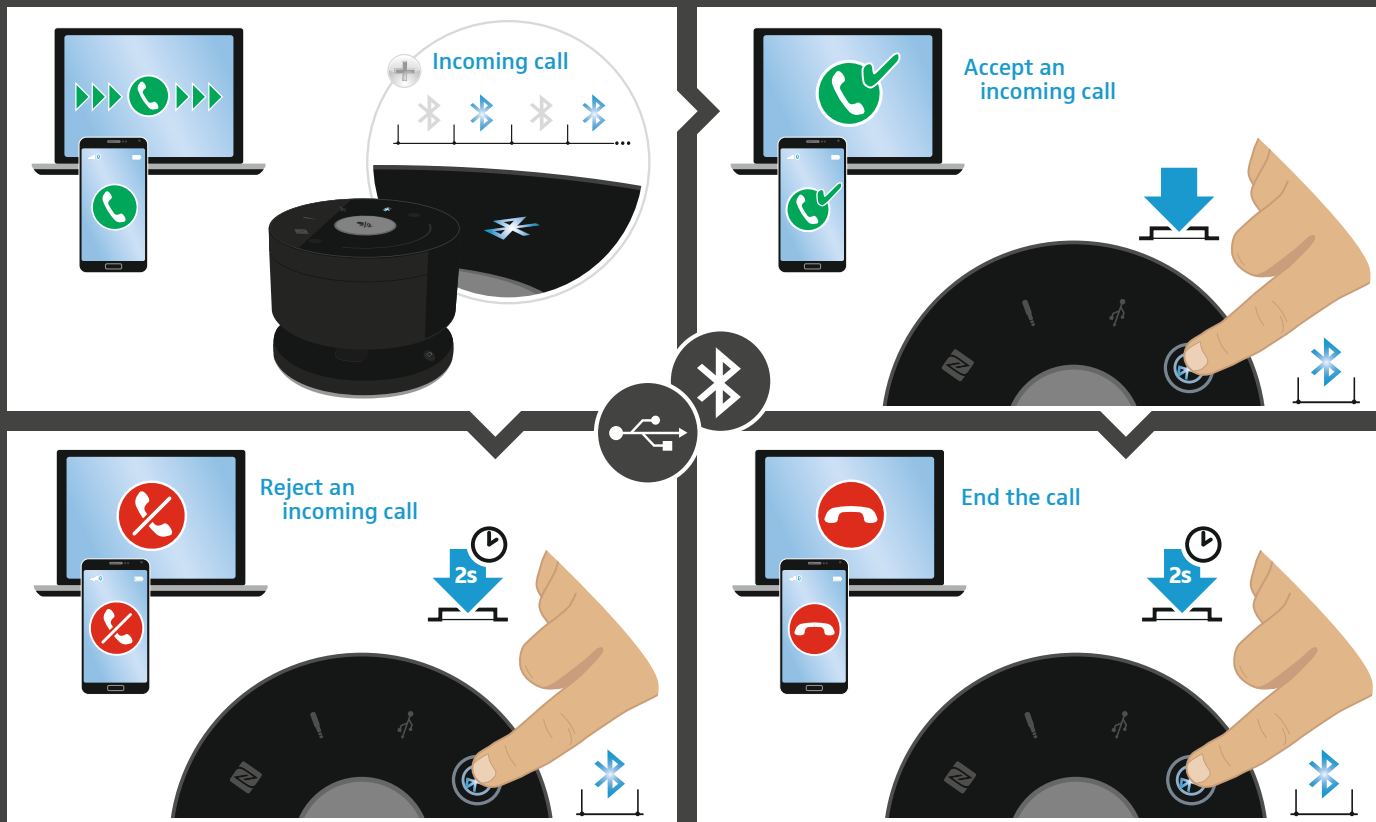

5 Using the product

Adding a connection

Verbindung hinzufügen

Ajouter une connexion

Añadir conexión

Adicionar ligação

Προσθήκη σύνδεσης

Aggiunta di una
connessione

Een verbinding toevoegen

接続を追加する

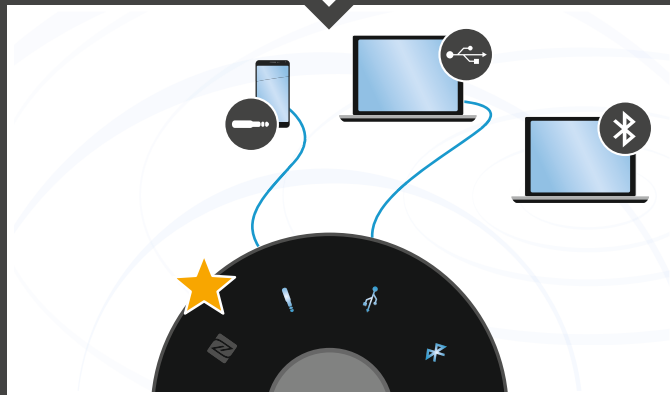
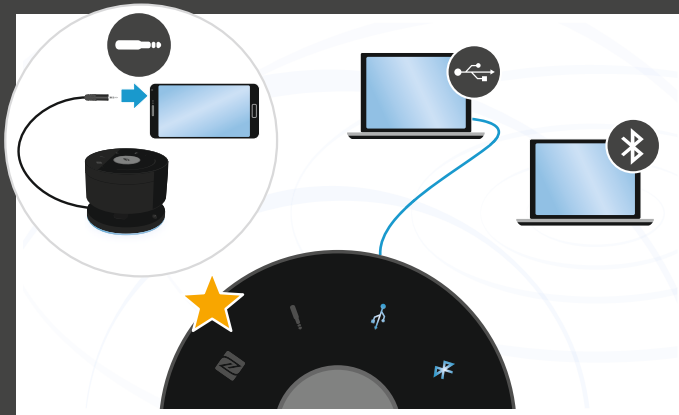

5 Using the product

Deactivating a connection

Verbindung deaktivieren

Désactiver une connexion

Desactivar conexión

Desativar ligação

Απενεργοποίηση συνδέσεων

Disattivazione connessione

Verbinding uitschakelen

接続を非アクティブにする

1 Touch and hold
the Bluetooth icon

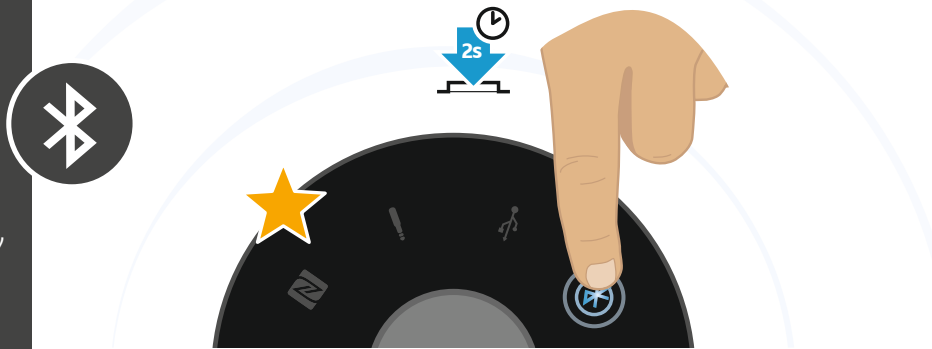

2

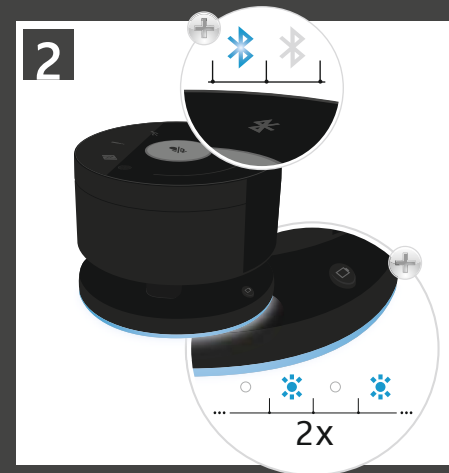

3

All connections
deactivated...



...Bottom LEDs
light up

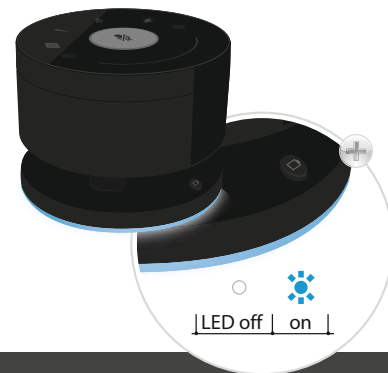

1

2

3

4

5

6

7

5 Using the product

Ending a remote conference

Web- oder
Telekonferenz beenden

Terminer une conférence
web ou une téléconférence

Finalizar una conferencia
web o telefónica

Terminar conferência
telefónica ou online

Τερματισμός διαδικτυακής ή
τηλεφωνικής συνδιάσκεψης

Terminare conferenze
Web o teleconferenze

Web- of telefonische
conferentie beëindigen

ウェブ会議または電話会
議を終了する

1 End the call via
your device(s)...

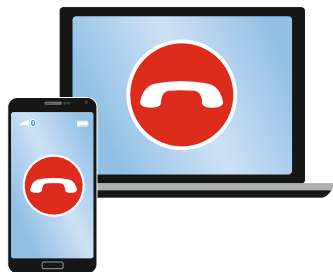

... or via touch on the
USB or Bluetooth icon

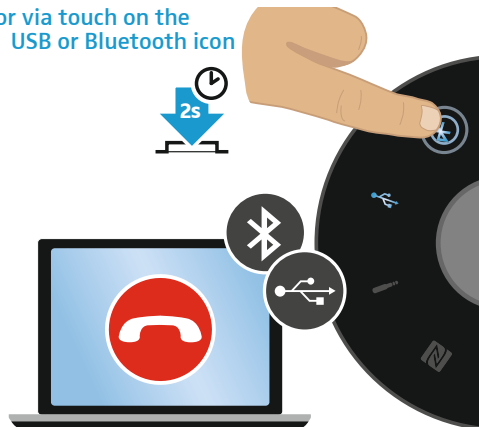

2 Disconnect
the USB
cable

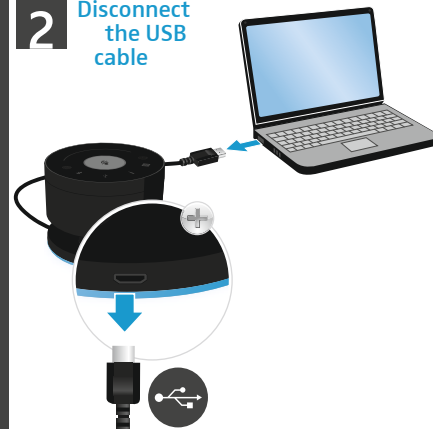

3 Disconnect the audio
or telephone cable

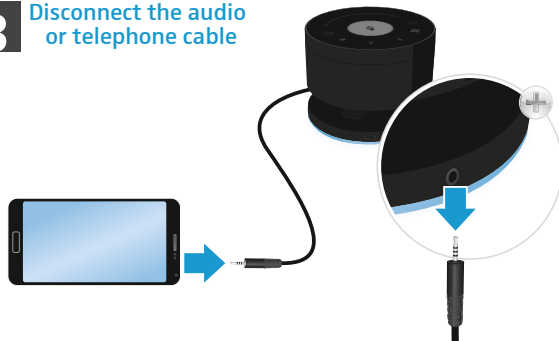

4 Charge the
satellites

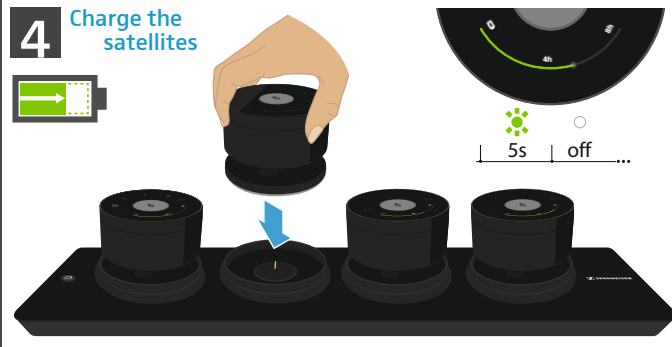

5 Using the product

Verifying battery life

Verbleibende
Akkulaufzeit abfragen

Vérifier l'autonomie
restante des batteries

Consultar la autonomía
restante de las pilas
recargables

Consultar o tempo de
duração da bateria restante

Ενδειξη υπολειπόμενου
χρόνου λειτουργίας
μπαταριών

Verificare l'autonomia
residua della batteria

De resterende gebruiksduur
van de accu opvragen

残りのバッテリー作動時
間の確認

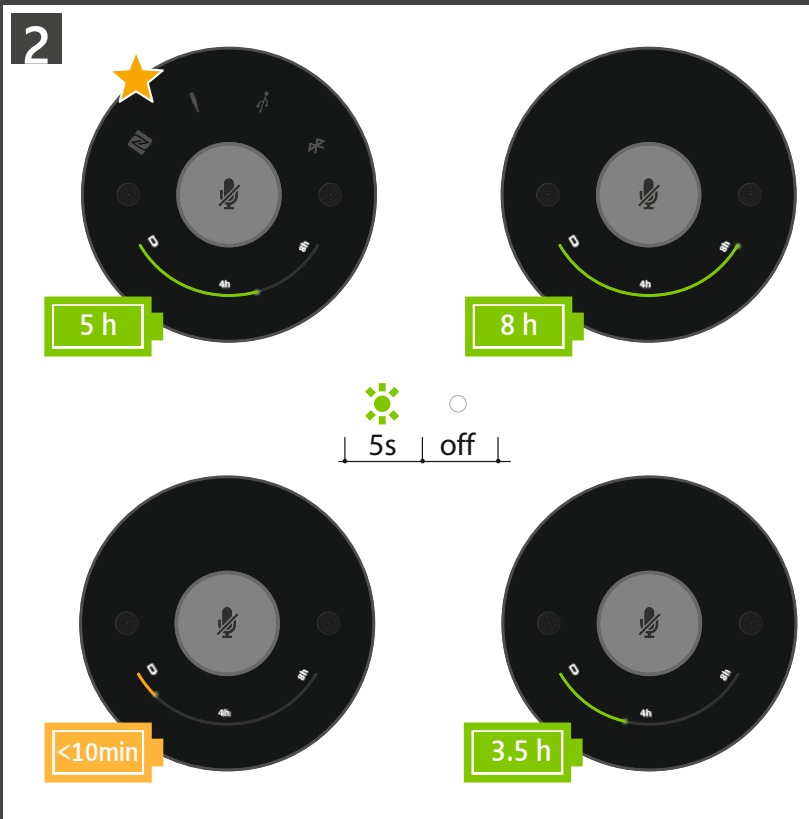
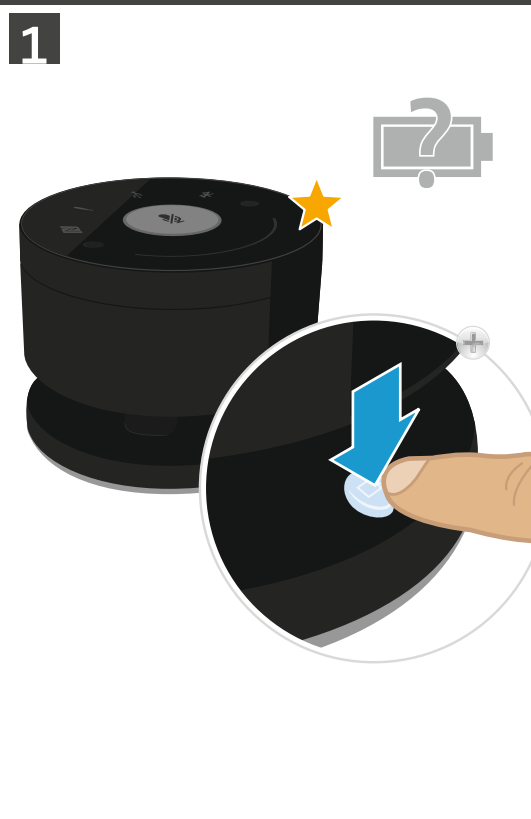

5 Using the product

Verifying battery life

Verbleibende
Akkulaufzeit abfragen

Vérifier l'autonomie
restante des batteries

Consultar la autonomía
restante de las pilas
recargables

Consultar o tempo de
duração da bateria restante

Ενδειξη υπολειπόμενου
χρόνου λειτουργίας
μπαταριών

Verificare l'autonomia
residua della batteria

De resterende gebruiksduur
van de accu opvragen

残りのバッテリー作動時
間の確認

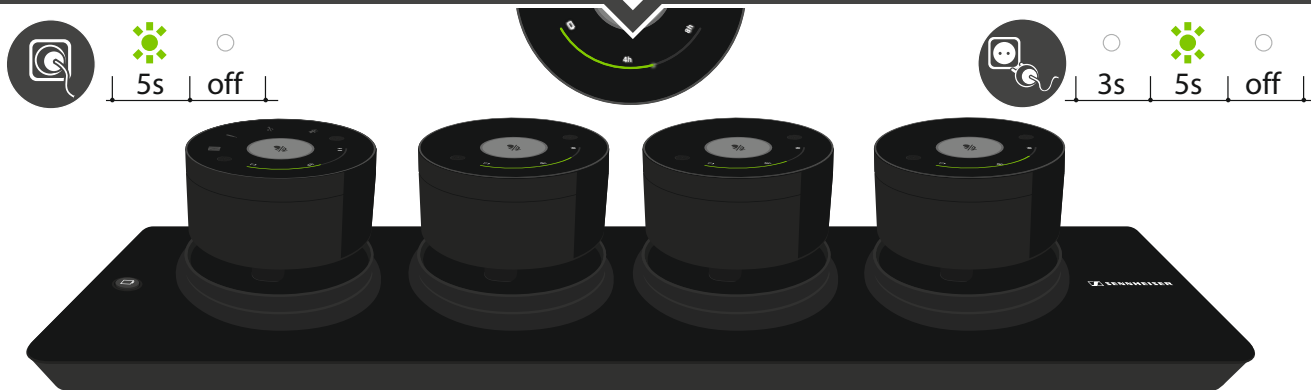
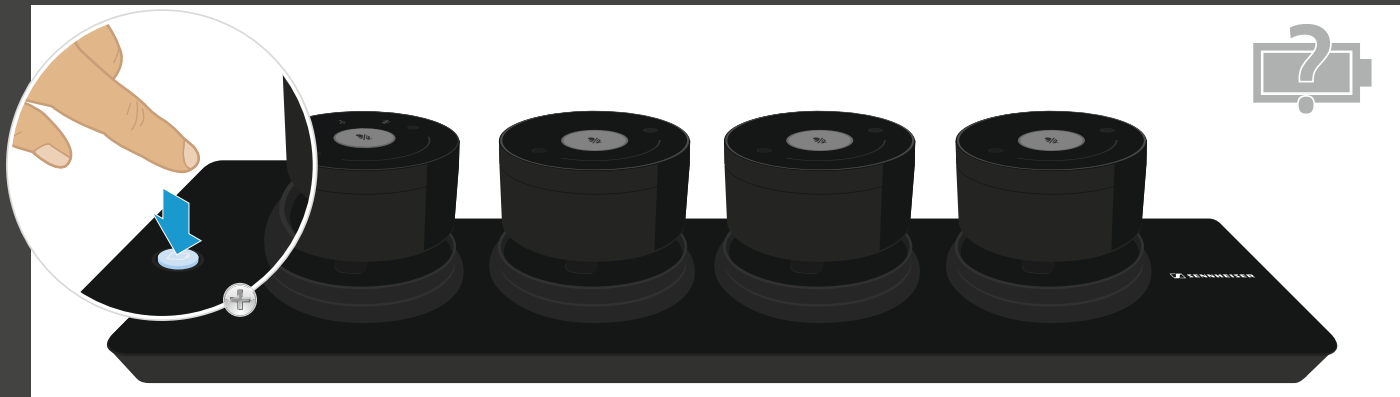

1

2

3

4

5

6

7

5 Using the product

Ending standby mode

Ruhezustand aufheben

Terminer l'état de repos

Finalizar el estado de reposo

Anular o estado de descanso

Ακύρωση αναστολής λειτουργίας

Annullare stato di inattività

De rusttoestand opheffen

スタンバイモードの解除

1

Standby mode = No connection for 45 minutes

...45 min | 1s | 20s | 1s | 20s ...

wake up from standby mode:
single touch on any satellite

... [gear icon] ✓

2

Sleep mode = No connection for 60 minutes

ZZZ
ZZZ
... [LED off]

wake up from sleep mode:
single touch on every satellite

Searching for the Master ★

... [gear icon] ✓

6 Charging

Charging the batteries

Akkus laden

Charger les batteries

Cargar las pilas recargables

Carregar as pilhas recarregáveis

Φόρτιση μπαταριών

Caricamento delle batterie

Accu's opladen

バッテリーを充電する

A Charge the Master via USB connection

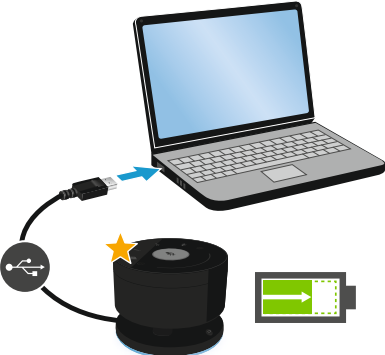

Diagram A illustrates charging the Master device via a USB connection. A laptop is connected to the Master device using a USB cable. A battery icon with a green arrow indicates charging.

B Charge all satellites

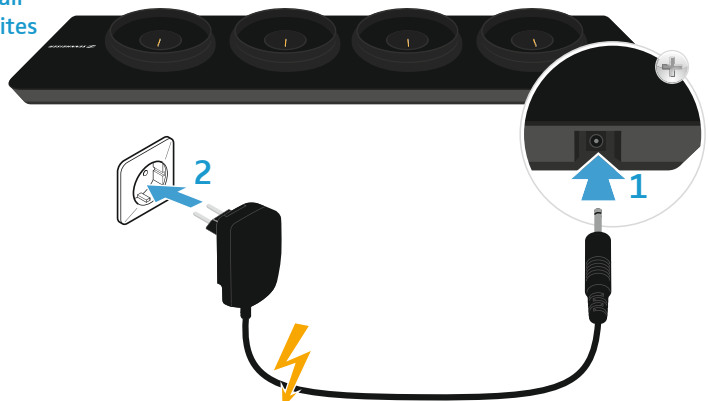

Diagram B illustrates charging all satellites. A power adapter is plugged into a wall outlet and connected to the Master device. A satellite is being inserted into the Master device. A battery icon with a green arrow indicates charging.

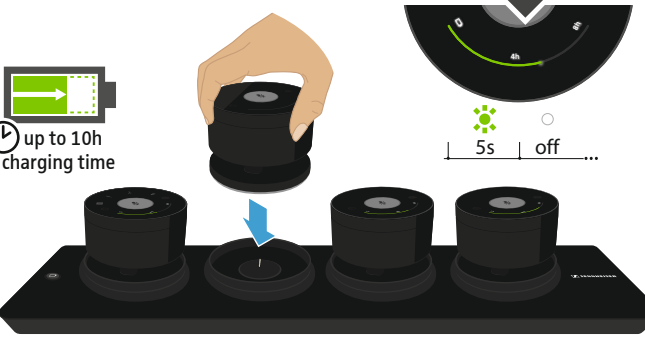

Diagram C illustrates inserting a satellite into the Master device. A hand is shown inserting a satellite into the Master device. A battery icon with a green arrow indicates charging. A timer icon shows "up to 10h charging time". A power button is shown with "5s" and "off".



Diagram D illustrates removing a satellite from the Master device. A hand is shown removing a satellite from the Master device. A battery icon with a green arrow indicates charging. A timer icon shows "up to 8h operating time". A power button is shown with "5s" and "off".

7 Cleaning and maintenance

Cleaning the system/
replacing the batteries

System reinigen/
Akkus wechseln

Nettoyer le système/
Remplacer les batteries

Limpiar el sistema/
Cambiar las pilas recargables

Limpar o sistema/
substituir as pilhas

Καθαρισμός συστήματος/
Αλλαγή μπαταριών

Pulizia del sistema/
sostituzione delle batterie

Het systeem schoonmaken/
de accu vervangen

システムを清掃する/
バッテリーを交換する

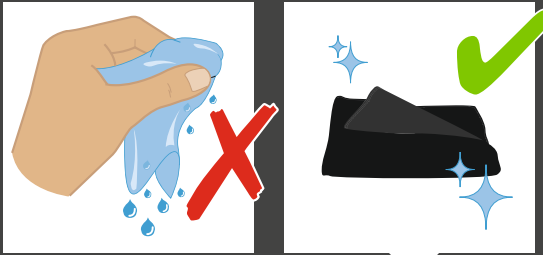

Replace the
rechargeable
battery

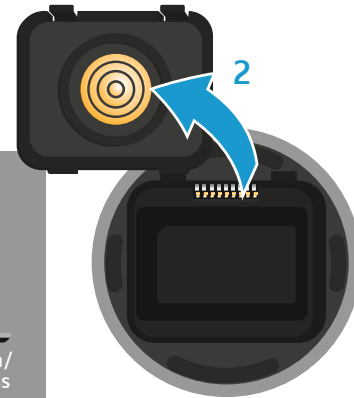
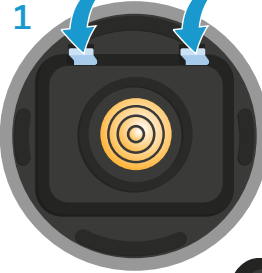

Accessories are
available at:



[www.sennheiser.com/
teamconnect-wireless](http://www.sennheiser.com/teamconnect-wireless)

7 Cleaning and maintenance

Updating the Firmware
Firmware aktualisieren
Mettre à jour le micrologiciel
Actualizar firmware
Atualizar o firmware
Ενημέρωση υλικολογισμικού
Aggiornamento del firmware
Firmware actualiseren
ファームウェアを更新する

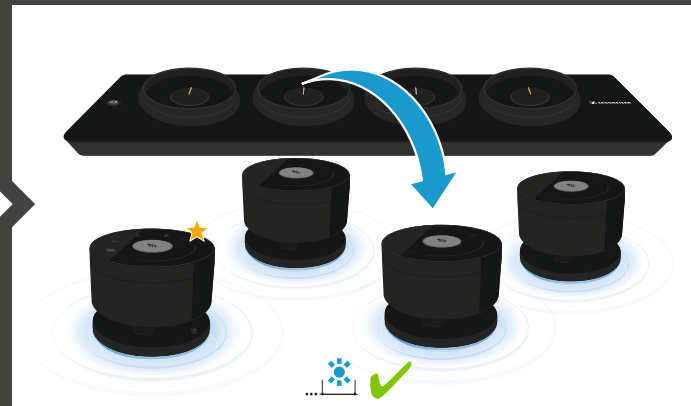
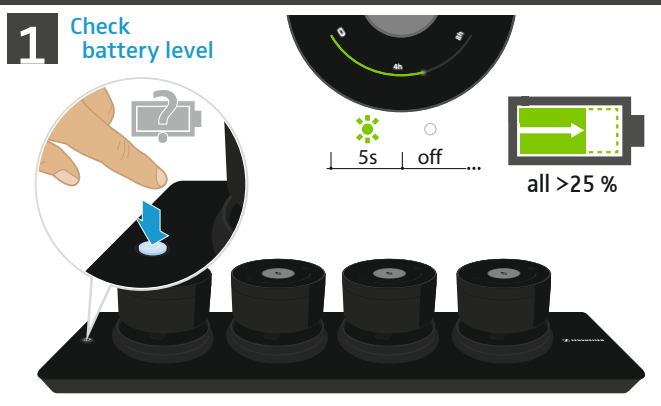

For further information

Please visit our website:



www.sennheiser.com/teamconnect-wireless

System identification:
Unique Set ID
for each system

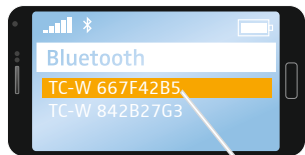

System 1

667F42B5

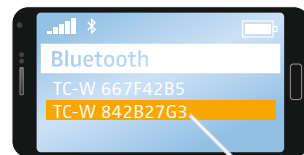

System 2

842B27G3





Sennheiser electronic GmbH & Co. KG

Am Labor 1, 30900 Wedemark, Germany
www.sennheiser.com

Printed in Germany, 571310, Publ. 12/17, A03