

Omega™ 4K/UHD HDMI Over HDBaseT TX/RX with USB, Control, and PoE AT-OME-EX-KIT



The Atlona **AT-OME-EX-KIT** is an HDBaseT extender for video up to 4K/60 4:2:0, plus embedded audio, control, Ethernet, and USB 2.0 over distances up to 330 feet (100 meters). Part of the Omega™ Series of integration products for modern AV communications and collaboration, the OME-EX-KIT is HDCP 2.2 compliant and extends IR, RS-232, and IP control signals. The integrated USB extension is ideal for software video conferencing and the use of touch or interactive displays. The OME-EX-TX transmitter includes a USB host port for a PC, plus two peripheral devices such as a speakerphone, microphone, or keyboard and mouse. The OME-EX-RX receiver provides two USB 2.0 interfaces for devices such as a camera or display. The transmitter and receiver are available separately, for use with other Omega Series integration products.*

Package Contents

- 1 x AT-OME-EX-TX
- 1 x AT-OME-EX-RX
- 2 x Captive screw connectors, 4-pin
- 2 x Mounting plates
- 4 x Mounting screws
- 1 x 48 V DC power supply
- 1 x Installation Guide



IMPORTANT: Visit <http://www.atlona.com/product/AT-OME-EX-KIT> for the latest firmware updates and User Manual.

* Both the AT-OME-EX-TX and AT-OME-EX-RX are not compatible with the AT-UHD-HDVS-300 system for extending USB.



AT-OME-EX-TX

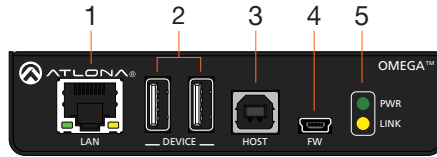

Front

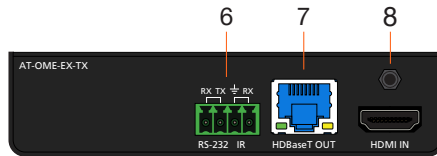

Rear

- 1 LAN**
Connect a category cable from this port to a network switch. This cable provide IP pass-through transport control from a control system to the display (sink) device connected to the receiver.
- 2 DEVICE**
Connect up to two USB devices (e.g. mouse, keyboard, etc.) to these ports.
- 3 HOST**
Connect a USB cable from this port to the host computer.
- 4 FW**
Connect a mini USB-to-USB cable from this port, to a computer, to update the firmware. Refer to [Updating the Firmware \(page 10\)](#) for more information.
- 5 PWR / LINK**
The **PWR** LED indicator will glow green when the AT-OME-EX-TX is powered. The AT-OME-EX-RX supplies power to the AT-OME-EX-TX over HDBaseT. The **LINK** LED indicator glows yellow when a solid link is established between the transmitter and receiver. Refer to [LED Indicators \(page 7\)](#) for more information.
- 6 RS-232 / IR**
Connect the included 4-pin captive screw block to this receptacle. Refer to [RS-232 and IR \(page 4\)](#) for more information.
- 7 HDBaseT OUT**
Connect a category cable from this port to the **HDBaseT IN** port of the AT-OME-EX-RX or other PoE-compatible receiver.
- 8 HDMI IN**
Connect an HDMI cable from this port to the source device.



AT-OME-EX-RX

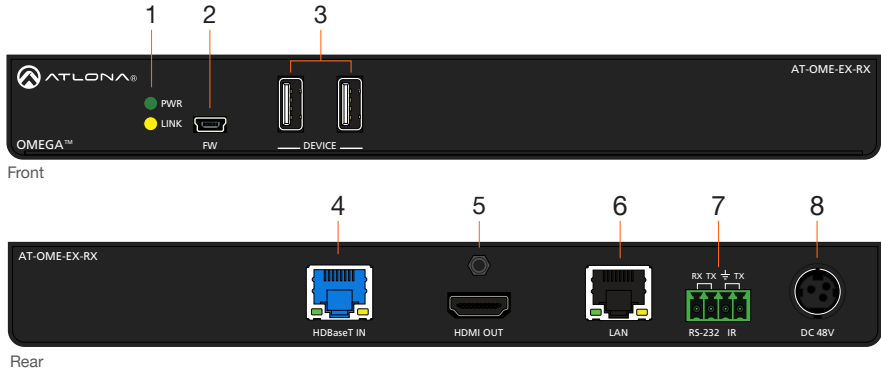

1 PWR / LINK

The **PWR** LED indicator will glow green when the AT-OME-EX-RX is powered. The **LINK** LED indicator glows yellow when a solid link is established between the transmitter and receiver. Refer to [LED Indicators \(page 7\)](#) for more information.

2 FW

Connect a mini USB-to-USB cable from this port, to a computer, to update the firmware. Refer to [Updating the Firmware \(page 10\)](#) for more information.

3 DEVICE

Connect up to two USB 2.0 devices (e.g. mouse, keyboard, etc.) to these ports.

4 HDBaseT IN

Connect a category cable from this port to the **HDBaseT OUT** port of the AT-OME-EX-TX. The AT-OME-EX-TX is powered by the AT-OME-EX-RX over HDBaseT.

5 HDMI OUT

Connect an HDMI cable from this port to the display (sink) device.

6 LAN

Connect a category cable from this port to the display (sink) device. This cable provides IP pass-through transport control to the display (sink) device, from a control system connected to the transmitter.

7 RS-232 / IR

Connect the included 4-pin captive screw block to this receptacle. Refer to [RS-232 and IR \(page 4\)](#) for more information.

8 DC 48V

Connect the included 48 V DC power supply to this power receptacle.



RS-232 and IR

The AT-OME-EX-KIT provides pass-through transport of RS-232 protocol and/or IR over HDBaseT, which allows communication between a control system and an RS-232 or IR device. This step is optional.

1. Use wire strippers to remove a portion of the cable jacket.
2. Remove at least 3/16" (5 mm) from the insulation of the RX, TX, and GND wires for the RS-232 connection.
3. Insert the TX, RX, and GND wires into correct terminal using one of the included 4-pin captive screw connectors.
4. Repeat step 2 for the S and GND wires for the IR connection.
5. Insert the S (signal) wire in to the TX terminal and the ground wire to the GND terminal.
6. Tighten the captive screws to secure the wires in place. Do not over-tighten or use high-torque devices to prevent damage to the connector block.



NOTE: Typical DB9 connectors use pin 2 for TX, pin 3 for RX, and pin 5 for ground. On some devices functions of pins 2 and 3 are reversed. Note that the signal (S) pin for the IR is labeled as "TX" on the port.

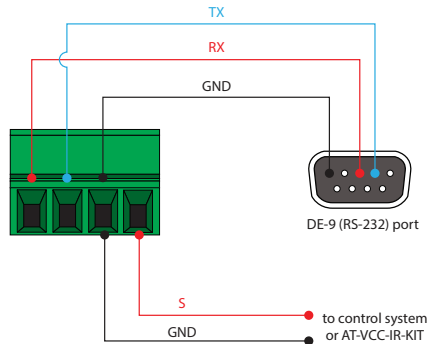
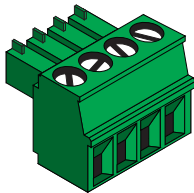

Installation

1. Connect a UHD/HD source to the **HDMI IN** port on the transmitter.
2. Connect a UHD/HD display to the **HDMI OUT** port on the receiver.
3. Connect a USB cable from the host computer to the **HOST** port on the transmitter.
4. Connect up to two USB devices (speakerphone, etc.) to the **DEVICE** ports on the transmitter.
5. Connect up to two USB devices (mouse, keyboard, etc.) to the **DEVICE** ports on the receiver.
6. Connect a category cable, from the **HDBaseT OUT** port on the transmitter, to the **HDBaseT IN** port on the receiver.
7. OPTIONAL: Connect an Ethernet cable from the **LAN** port, on the transmitter to a network switch. This cable provide IP pass-through transport control from a control system to the display (sink) device connected to the receiver. Connect an Ethernet cable from the **LAN** port, on the receiver, to the display (sink) device.
8. OPTIONAL: Connect an RS-232 cable between a control system and the **RS-232** port on the transmitter. Connect the RS-232 device to the **RS-232** port on the receiver. Refer to [RS-232 and IR \(page 4\)](#) for more information.
9. OPTIONAL: Connect an IR emitter to the **IR** port on the transmitter. Connect an IR receiver to the **IR** port on the receiver. Refer to [RS-232 and IR \(page 4\)](#) for more information.
10. Connect the included 48 V DC power supply to the **DC 48V** power receptacle on the transmitter.
11. Connect the power supply to an available AC outlet.

Cable Recommendation Guidelines

Refer to the tables below for recommended cabling when using Altona products with HDBaseT. The green bars indicate the signal quality when using each type of cable. Higher-quality signals are represented by more bars.

Core	Shielding	CAT5e	CAT6	CAT6a	CAT7
Solid	UTP (unshielded)	■	■■■	■■■■	N/A
	STP (shielded)	■■	■■■■	■■■■■	■■■■■



IMPORTANT: Stranded or patch cables are not recommended due to performance issues.

Cable*	Max. Distance @ 4K	Max. Distance @ 1080p
CAT5e	295 feet (90 meters)	330 feet (100 meters)
CAT6 / CAT6a / CAT7	330 feet (100 meters)	330 feet (100 meters)



*Altona recommends TIA/EIA 568-B termination for optimal performance.

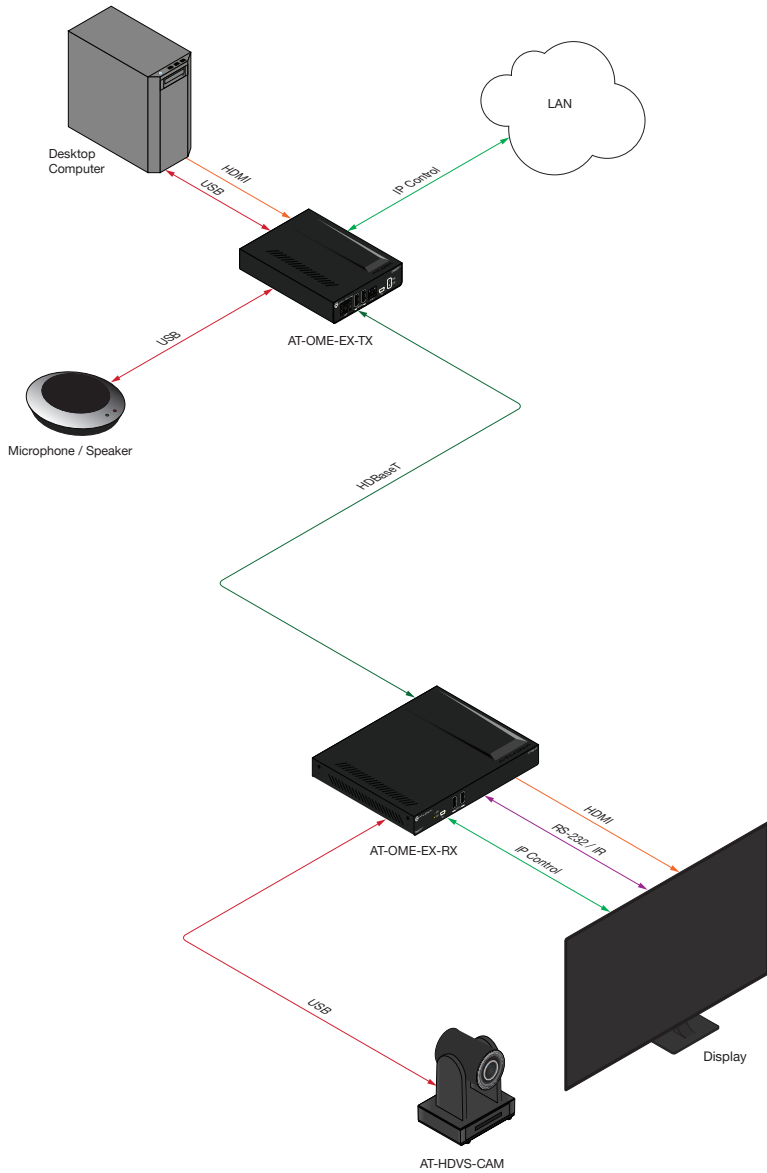

Connection Diagram



LED Indicators

The **PWR** and **LINK** LED indicator on both the transmitter and receiver unit provides basic information on the current status of the AT-OME-EX-KIT. The information in the table below applies to both the transmitter and receiver unit.

PWR		Description
Solid green		Unit is powered.
Off		Unit is not powered. <ul style="list-style-type: none"> • Verify that the locking connector is securely fastened to the power receptacle. • Make sure that the power supply is connected to an active AC outlet.

LINK		Description
Solid yellow		The link integrity between the transmitter and the receiver is good.
Blinking yellow		Poor signal integrity between the transmitter and the receiver. <ul style="list-style-type: none"> • Make sure that the category cable between the HDBaseT IN port on the transmitter and the HDBaseT OUT port on the receiver is secure. • The category cable may be compromised. Try using a different category cable. Make sure that the cable is solid core. Stranded or patch cables are not recommended.
Off		The link integrity between the transmitter and the receiver is compromised. <ul style="list-style-type: none"> • Check the category cable between the HDBaseT IN port on the transmitter and the HDBaseT OUT port on the receiver.

Mounting Instructions

Both the AT-OME-EX-TX and AT-OME-EX-RX provide two mounting brackets, which can be used to attach the unit to any flat surface. Use the two enclosure screws, on the sides of the unit to attach the mounting brackets.

1. Using a small Phillips screwdriver, remove the two screws from the left side of the enclosure.

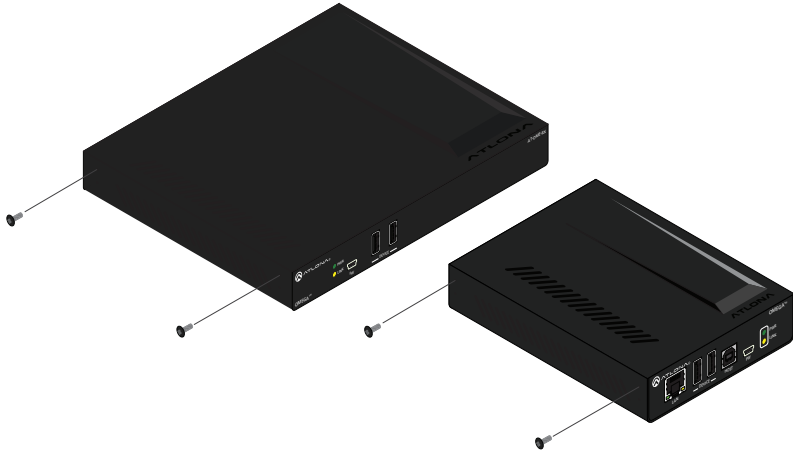

2. Position one of the mounting brackets, as shown below, aligning the holes on the side of the enclosure with one set of holes on the mounting bracket.
3. Use the screws from Step 1 to attach the mounting bracket.





4. Repeat these steps to attach the second mounting bracket to the opposite side of the unit.
5. Mount the unit to a flat surface using the oval-shaped holes, on each mounting bracket. If using a drywall surface, a #6 drywall screw is recommended.



Updating the Firmware

Requirements:

- AT-OME-EX-TX
- AT-OME-EX-RX
- Firmware file
- Computer running Windows
- USB-A to USB mini-B cable



NOTE: The procedure outlines the update process for the AT-OME-EX-TX. However, the same procedure applies to the AT-OME-EX-RX. The AT-OME-EX-TX and AT-OME-EX-RX can be updated in any order. The update process, for each unit, can take up to five minutes to complete.

1. Disconnect power from the unit.
2. Connect a USB-A to USB mini-B cable between the PC and the **FW** port on the unit.
3. Power the unit. If updating the AT-OME-EX-TX, then make sure the receiver is powered using the included power supply and a category cable is connected between the HDBaseT ports of both the transmitter and receiver units.
4. The USB UPDATE folder will be displayed. If this folder is not displayed, automatically, select the USB UPDATE drive from Windows Explorer.

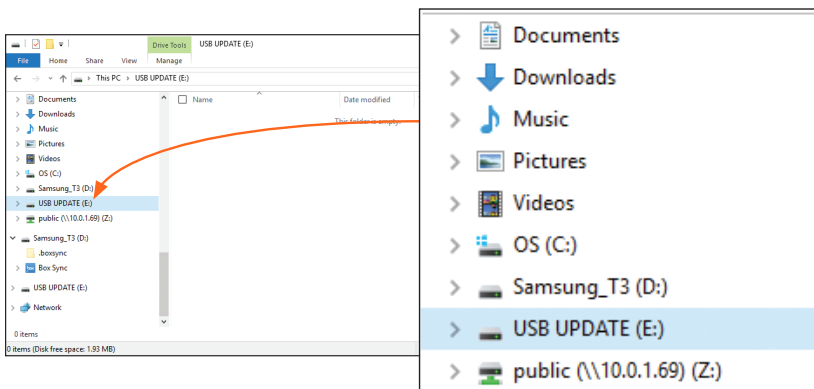

5. Delete all files from the USB UPDATE drive, if any are present.
6. Drag-and-drop the firmware file to the drive.
7. The **PWR** LED indicator, on the front panel, will flash green while the unit is being updated. Do not disconnect the USB cable during the update process. When the **PWR** LED stops flashing and is solid green, the update process will be complete.
8. Disconnect the USB cable from the unit and repeat the above steps for the AT-OME-EX-RX.

Notes



Toll free US International
atlona.com • 877.536.3976 • 41.43.508.4321