

BOSE

BOSE[®]



PowerMatch
Configurable Professional Power Amplifier



PowerMatch
Configurable Professional Power Amplifier

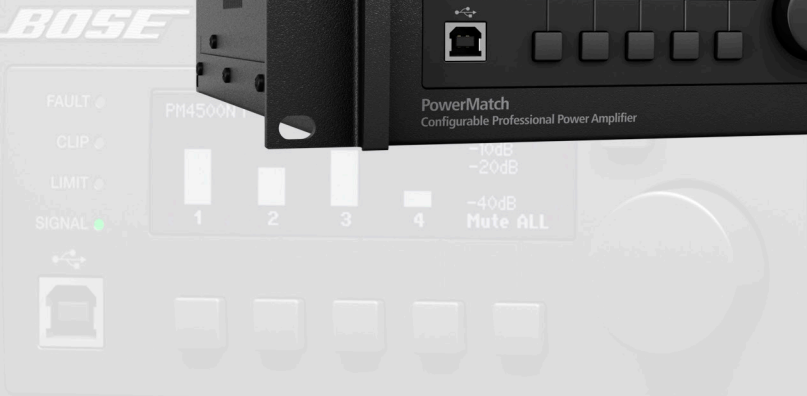

PowerMatch
Configurable Professional Power Amplifier

- PM8500 / PM8500N**
- PM8250 / PM8250N**
- PM4500 / PM4500N**
- PM4250 / PM4250N**

PowerMatch[®]

Configurable Professional Power Amplifiers

Installation and Operating Guide

BOSE PROFESSIONAL

pro.bose.com

PowerMatch
Configurable Professional Power Amplifier

WARNING: This product is intended for installation by professional installers only.

Thank you for selecting Bose® PowerMatch® amplifiers for your sound reinforcement system. This document is intended to provide professional installers with basic installation and safety guidelines for Bose PowerMatch amplifiers in typical fixed-installation systems. Please read this document before attempting installation.

WARNING: Do not expose this apparatus to dripping or splashing, and do not place objects filled with liquids such as vases, on or near the apparatus. As with any electronic products, use care not to spill liquids into any part of the system. Liquids can cause a failure and/or a fire hazard.

WARNING: To reduce the risk of fire or electric shock, do not expose this apparatus to rain.

WARNING: Do not place any naked flame sources, such as lighted candles, on or near the apparatus.

WARNING: Avoid touching uninsulated wiring or wiring terminals. This product's audio wiring terminals carry voltage that can result in discomfort upon contact.

Note: The product must be used indoors. It is neither designed nor tested for use outdoors, in recreational vehicles, or on boats.

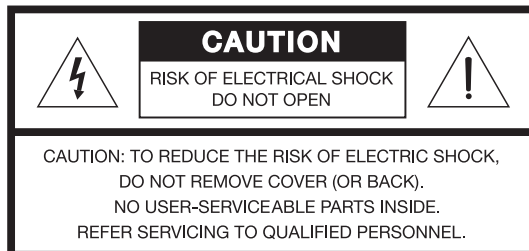

 The lightning flash with arrowhead symbol, within an equilateral triangle, is intended to alert the user to the presence of uninsulated dangerous voltage within the system enclosure that may be of sufficient magnitude to constitute a risk of electrical shock. Do not touch the output terminals while amplifier power is ON. Make all connections with amplifier OFF.

 The exclamation point within an equilateral triangle, as marked on the system, is intended to alert the user to the presence of important operating and maintenance instructions in this installation guide.

CAUTION: Make no modifications to the amplifier or accessories. Unauthorized alterations may compromise safety, regulatory compliance, and system performance.

CAUTION: This product shall be connected to an AC mains socket outlet with a protective earthing (grounding) connection.

CAUTION: Where the AC mains plug is used as the disconnect device, such disconnect device shall remain fully operable.

Important Safety Instructions

1. **Read these instructions.**
2. **Keep these instructions** – for future reference.
3. **Heed all warnings** – on the product and in all product documentation.
4. **Follow all instructions.**
5. **Do not use this apparatus near water or moisture.**
6. **Clean only with a dry cloth.**
7. **Do not block any ventilation openings. Install in accordance with the manufacturer's instructions. To ensure reliable operation of the product and to protect it from overheating, put the product in a position and location that will not interfere with its proper ventilation.**
8. **Do not install near any heat sources, such as radiators, heat registers, stoves, or other apparatus (including amplifiers) that produce heat.**
9. **Do not defeat the safety purpose of the polarized or grounding-type plug. A polarized plug has two blades with one wider than the other. A grounding-type plug has two blades and a third grounding prong. The wider blade or third prong is provided for your safety. If the provided plug does not fit in your outlet, consult an electrician for replacement of the obsolete outlet.**
10. Protect the power cord from being walked on or pinched, particularly at plugs, convenience receptacles, and the point where they exit from the apparatus.
11. **Only use attachments/accessories specified by the manufacturer.**
12. **Use only with the cart, stand, tripod, bracket, or table specified by the manufacturer or sold with the apparatus. When a cart is used, use caution when moving the cart/apparatus combination to avoid injury from tip-over.** 
13. Unplug this apparatus during lightning storms or when unused for long periods of time to prevent damage to this product.
14. **Refer all servicing to qualified service personnel. Servicing is required when the apparatus has been damaged in any way such as power-supply cord or plug is damaged; liquid has been spilled or objects have fallen into the apparatus; the apparatus has been exposed to rain or moisture, does not operate normally, or has been dropped.** Do not attempt to service this product yourself. Opening or removing covers may expose you to dangerous voltages or other hazards. Please call Bose to be referred to an authorized service center near you.
15. To prevent risk of fire or electric shock, avoid overloading wall outlets, extension cords, or integral convenience receptacles.
16. **Do not let objects or liquids enter the product** – as they may touch dangerous voltage points or short-out parts that could result in a fire or electric shock.
17. **See product enclosure for safety-related markings.**
18. **The front panel LCD screen will illuminate when the product has mains power. If power is applied and the LCD screen is not**

illuminated, please send the unit for service.

19. Do not allow the unit to exceed the maximum operating ambient temperature of 40° C. Be aware of conditions in an enclosed rack that may increase the temperature above room ambient conditions.



This product conforms to all applicable EU directive requirements. The complete declaration of conformity can be found at www.Bose.com/compliance.

This product conforms to all applicable Electromagnetic Compatibility Regulations 2016 and all other applicable UK regulations. The complete declaration of conformity can be found at: www.Bose.com/compliance

 This symbol means the product must not be discarded as household waste, and should be delivered to an appropriate collection facility for recycling. Proper disposal and recycling helps protect natural resources, human health and the environment. For more information on disposal and recycling of this product, contact your local municipality, disposal service, or the shop where you bought this product.

This Product meets the immunity requirements for the E2 class EN55103-2 directive.

Initial turn on inrush current: 14.8 Amps (230V / 50 Hz)

Inrush current after 5 seconds AC mains interruption: 15.4 Amps (230V / 50 Hz)

Information About Products That Generate Electrical Noise (FCC Compliance Notice for U.S.)

Note: This equipment has been tested and found to comply with the limits for a Class A digital device, pursuant to part 15 of the FCC Rules. These limits are designed to provide reasonable protection against harmful interference when the equipment is operated in a commercial environment. This equipment generates, uses, and can radiate radio frequency energy and, if not installed and used in accordance with the instruction manual, may cause harmful interference to radio communications. Operation of this equipment in a residential area is likely to cause harmful interference in which case the user will be required to correct the interference at one's own expense.

This product complies with CAN ICES-3 (A)/NMB-3 (A).

China Restriction of Hazardous Substances Table

中国有害物质限制表

Names and Contents of Toxic or Hazardous Substances or Elements 有毒或有害物质或元素的名称及成分						
Toxic or Hazardous Substances and Elements 有毒或有害物质和元素						
Part Name 零件名称	Lead 铅 (Pb)	Mercury 汞 (Hg)	Cadmium 镉 (Cd)	Hexavalent 六价铬 (CR(VI))	Polybrominated Biphenyl 多溴化联苯 (PBB)	Polybrominated diphenylether 多溴二苯醚 (PBDE)
PCBs 印刷电路板	X	O	O	O	O	O
Metal Parts 金属零件	X	O	O	O	O	O
Plastic Parts 塑料零件	O	O	O	O	O	O
Speakers 扬声器	X	O	O	O	O	O
Cables 线缆	X	O	O	O	O	O

This table is prepared in accordance with the provisions of SJ/T 11364.
此表格符合 SJ/T 11364 条款。

O: Indicates that this toxic or hazardous substance contained in all of the homogeneous materials for this part is below the limit requirement of GB/T 26572.
O: 表示此零件中所有同类物质包含的有毒或有害物质低于 GB/T 26572 中的限定要求。

X: Indicates that this toxic or hazardous substance contained in at least one of the homogeneous materials used for this part is above the limit requirement of GB/T 26572.
X: 表示此零件使用的同类物质中至少有一种包含的有毒或有害物质高于 GB/T 26572 中的限定要求。



Taiwan Restriction of Hazardous Substances Table

台灣 BSMI 限用物質含有情況標示

Equipment name: PowerMatch Amplifiers 設備名稱: 擴大機			Type designation 型號: 361810, 361811, 361813, 361814, 361815, 361816, 343547, 343546			
Restricted substances and its chemical symbols 限制物質及其化學符號						
Unit 裝置	Lead (Pb) 鉛	Mercury (Hg) 汞	Cadmium (Cd) 鎘	Hexavalent chromium (Cr+6) 六價鉻	Polybrominated biphenyls (PBB) 多溴化聯苯	Polybrominated diphenyl ethers (PBDE) 多溴聯苯醚
PCBs 印刷電路板	-	O	O	O	O	O
Metal Parts 金屬零件	-	O	O	O	O	O
Plastic Parts 塑膠零件	O	O	O	O	O	O
Speakers 揚聲器	-	O	O	O	O	O
Cables 連接線	-	O	O	O	O	O

Note 1: "O" indicates that the percentage content of the restricted substance does not exceed the percentage of reference value of presence.
備註 1: 「O」表示限制物質的濃度百分比含量未超過參考值。

Note 2: The "-" indicates that the restricted substance corresponds to the exemption.
備註 2: 「-」表示限制物質屬於豁免項目範圍。

ADVERTENCIA: Solo un instalador profesional deberá montar este producto.

Gracias por seleccionar los amplificadores Bose® PowerMatch® para su sistema de refuerzo de sonido. Este documento ofrece a los instaladores profesionales instrucciones básicas de instalación y seguridad para los amplificadores Bose PowerMatch en sistemas típicos de instalación fija. Lea este documento antes de intentar la instalación.

ADVERTENCIA: No exponga este aparato a salpicaduras o goteo. No coloque encima o cerca del aparato objetos que contengan líquidos, como jarrones. Al igual que con cualquier producto electrónico, evite que se derramen líquidos en los componentes del sistema, ya que pueden provocar averías o riesgo de incendio.

ADVERTENCIA: Con el fin de reducir el riesgo de descarga eléctrica, no exponga este producto a la lluvia o humedad.

ADVERTENCIA: No coloque sobre el aparato o cerca de éste llamas vivas, como por ejemplo, velas.

ADVERTENCIA: Evite tocar el cableado no aislado o los terminales de cableado. Los terminales de cableado de audio de este producto transmiten voltaje que puede causar incomodidad al contacto.

Nota: Este producto debe utilizarse en interiores. No está diseñado ni ha sido probado para uso al aire libre ni en embarcaciones.



 El símbolo de relámpago con una flecha dentro de un triángulo equilátero indica al usuario que la caja del sistema puede contener una tensión sin aislar de magnitud suficiente para constituir un riesgo de descarga eléctrica. No toque los terminales de salida mientras el amplificador está encendido. Realice todas las conexiones con el amplificador apagado.

 El signo de exclamación dentro de un triángulo equilátero, tal como aparece marcado en el sistema, avisa al usuario de que existen instrucciones de operación y mantenimiento importantes en esta guía de instalación.

PRECAUCIÓN: No realice modificaciones en el amplificador o los accesorios. Las alteraciones no autorizadas pueden comprometer aspectos de seguridad, cumplimiento normativo y rendimiento del sistema.

PRECAUCIÓN: Este producto se debe conectar a una toma de la red eléctrica con una conexión de tierra que sirva de protección.

PRECAUCIÓN: Si se utiliza la clavija de red como dispositivo de desconexión, deberá poder accionarse fácilmente.

Instrucciones de seguridad importantes

1. Lea las siguientes instrucciones.
2. Guarde estas instrucciones por si necesita consultarlas en el futuro.
3. Respete todas las advertencias que se indican en el producto y en la documentación.
4. Siga todas las instrucciones.
5. No utilice este aparato cerca del agua o humedad.
6. Límpielo sólo con una bayeta seca.
7. No bloquee las aberturas de ventilación. Realice la instalación de acuerdo con las instrucciones del fabricante. Para garantizar el buen funcionamiento del producto y para protegerlo del sobrecalentamiento, colóquelo en una posición y una ubicación que no interfiera con una ventilación adecuada.
8. No lo instale cerca de fuentes de calor, tales como radiadores, salidas de aire caliente, cocinas u otros aparatos (incluidos amplificadores) que generen calor.
9. No elimine el mecanismo de seguridad del enchufe con toma a tierra o polarizado. Los enchufes polarizados disponen de dos clavijas, una de mayor tamaño que la otra. Los enchufes con toma a tierra tienen dos clavijas y un tercer terminal de tierra. La patilla más ancha y el tercer terminal se incluyen como medida de seguridad. Si el enchufe suministrado no encaja en la toma, póngase en contacto con un electricista para sustituir la toma antigua.
10. Proteja el cable de alimentación de forma que nadie lo pise ni quede pinzado, en particular cerca de enchufes, receptáculos de tomas múltiples y en el lugar en que sale del aparato.
11. Utilice sólo conexiones y accesorios suministrados por el fabricante.
12. Utilícelo sólo con el carrito, soporte, trípode, abrazadera o mesa suministrados por el fabricante o incluidos con el dispositivo. Cuando utilice un carrito, tenga cuidado al mover el carrito con el dispositivo para evitar que caiga y produzca daños.
13. Desenchufe el dispositivo si se produce una tormenta eléctrica o si no lo va a utilizar durante periodos prolongados de tiempo para evitar que se dañe.



14. **Toda reparación debe ser realizada por personal cualificado. Lleve el dispositivo a reparar si presenta algún daño como, por ejemplo, si el cable de alimentación o el enchufe están dañados, si se han vertido líquidos o se han caído objetos sobre el dispositivo o si éste ha estado expuesto a la lluvia o humedad; si no funciona correctamente o se ha caído al suelo.** No intente reparar este producto usted mismo. La apertura o retirada de las tapas le expondrá a tensiones peligrosas o a otros peligros. Póngase en contacto con Bose para conocer cuál es el centro de servicio técnico autorizado de su zona.
15. Para prevenir el riesgo de incendio o descargas eléctricas, evite sobrecargar los enchufes, alargadores o receptáculos de las tomas.
16. **Evite que caigan objetos o líquidos sobre el producto**, ya que podrían entrar en contacto con puntos de niveles de alta tensión o piezas que podrían sufrir un cortocircuito y causar incendios o descargas eléctricas.
17. **Consulte las indicaciones de seguridad en la caja del producto.**
18. **La pantalla LCD del panel frontal se ilumina cuando el producto está conectado a la red. Si se conecta el aparato y no se ilumina la pantalla LCD, envíelo a reparar.**
19. **No exponga la unidad a temperaturas superiores a 40° C, su temperatura máxima de funcionamiento. Tenga en cuenta todas las situaciones que pueden darse en un bastidor cerrado y que podrían aumentar la temperatura por encima de las condiciones ambientales de la sala.**



Este producto cumple todos los requisitos aplicables de las Directivas de la UE. Encontrará la declaración de conformidad completa en www.Bose.com/compliance.



Este producto cumple con todas las regulaciones aplicables de compatibilidad electromagnética de 2016 y todas las demás regulaciones aplicables del Reino Unido. La declaración de conformidad completa se puede encontrar en: www.Bose.com/compliance

 Este símbolo significa que el producto no debe desecharse como residuo doméstico y debe enviarse a una planta para tratamiento de residuos apropiada para su reciclado. Una eliminación y un reciclado adecuados ayudan a proteger los recursos naturales, la salud humana y el medioambiente. Para obtener más información acerca de la eliminación y el reciclado de este producto, comuníquese con su municipalidad local, un centro de servicios de desecho o la tienda donde compró este producto.

Este producto cumple los requisitos de inmunidad que establece la Directiva EN55103-2 para la clase E2.

Corriente de irrupción en encendido inicial: 14,8 Amps (230 V / 50 Hz)

Corriente de irrupción después de 5 segundos de interrupción de la corriente de red: 15,4 Amps (230 V / 50 Hz)

Información sobre productos que generan ruido eléctrico (Nota de homologación FCC para EE UU)

Nota: este equipo se ha probado y ha demostrado que cumple con los límites para dispositivos digitales de clase B, de acuerdo con el apartado 15 de las normas de la FCC. Estos límites están diseñados para ofrecer una protección razonable contra las interferencias perjudiciales cuando el aparato se utiliza en un entorno comercial. Este equipo genera, utiliza y puede irradiar energía de radiofrecuencia y, si no se instala y se utiliza de acuerdo con el manual de instrucciones, podría ocasionar interferencias perjudiciales para las comunicaciones por radio. La utilización de este equipo en una zona residencial podría causar interferencias dañinas. En ese caso, la corrección de la interferencia correrá a cargo del usuario.

Este producto cumple la norma CAN ICES-3 (A)/NMB-3 (A).

AVERTISSEMENT : l'installation de ce produit est réservée à un technicien professionnel.

Merci d'avoir choisi des amplificateurs professionnels Bose® PowerMatch® pour votre système d'amplification du son. Ce document à l'intention des installateurs professionnels contient les directives de pose et de sécurité relatives aux amplificateurs professionnels Bose PowerMatch en installation fixe. Lisez attentivement ce document avant l'installation.

AVERTISSEMENT : protégez l'appareil de tout risque de ruissellement ou d'éclaboussure. Ne placez pas d'objets contenant des liquides, tels que des vases, sur l'appareil. Comme avec tout appareil électronique, veillez à ne pas renverser de liquides sur une partie quelconque de l'appareil. Les liquides peuvent provoquer des pannes et/ou un risque d'incendie.

AVERTISSEMENT : afin de limiter les risques d'incendie ou d'électrocution, n'exposez jamais ce produit à la pluie.

AVERTISSEMENT : ne placez aucune source de flamme nue, comme une bougie allumée, sur ou près de l'appareil.

AVERTISSEMENT : Évitez de toucher les bornes ou éléments de câblages non isolés. Les bornes de connexion audio de ce produit sont sous tension, ce qui peut provoquer une sensation désagréable en cas de contact.

Remarque : ce produit doit être utilisé en intérieur. Il n'a pas été conçu ni testé pour une utilisation en extérieur, dans des véhicules ou sur des bateaux.



 Le symbole représentant un éclair avec une flèche à l'intérieur d'un triangle équilatéral est utilisé pour prévenir l'utilisateur de la présence d'une tension électrique dangereuse non isolée à l'intérieur de l'appareil. Cette tension est d'un niveau suffisamment élevé pour représenter un risque d'électrocution. Ne touchez pas les bornes de sortie lorsque l'amplificateur est allumé. Mettez l'amplificateur hors tension avant de réaliser toute connexion.

 Le symbole représentant un point d'exclamation à l'intérieur d'un triangle équilatéral, tel qu'il figure sur le système, signale à l'utilisateur la présence d'instructions importantes relatives au fonctionnement et à l'entretien de l'appareil dans cette notice d'installation.

ATTENTION : n'apportez aucune modification à l'amplificateur ou aux accessoires. Toute modification non autorisée peut compromettre votre sécurité, le respect des réglementations et les performances.

ATTENTION : cet appareil doit être raccordé à une prise secteur dotée d'une mise à la terre.

ATTENTION : si la fiche d'alimentation est utilisée comme dispositif de débranchement de l'appareil, elle doit rester facilement accessible.

Instructions importantes relatives à la sécurité

1. **Veillez lire ces instructions.**
2. **Conservez-les** pour toute référence ultérieure.
3. **Respectez tous les** avertissements qui figurent sur le produit ou dans sa documentation.
4. **Suivez toutes les instructions.**
5. **N'utilisez pas cet appareil à proximité d'eau ou d'une source d'humidité.**
6. **Utilisez uniquement un chiffon sec pour le nettoyage.**
7. **Ne bloquez jamais les orifices d'aération. Suivez les instructions du fabricant pour l'installation. Pour garantir un fonctionnement fiable du produit et le protéger contre tout risque de surchauffe, installez-le à un emplacement et dans une position permettant d'assurer une ventilation correcte.**
8. **N'installez pas cet appareil à proximité d'une quelconque source de chaleur, telle qu'un radiateur, une arrivée d'air chaud, un four ou tout autre appareil (notamment les amplificateurs) produisant de la chaleur.**
9. **Veillez à profiter de la sécurité offerte par les fiches de type terre ou polarisées. Les fiches polarisées sont équipées de deux bornes de largeurs différentes. Les fiches de type terre sont équipées de deux bornes et d'un orifice pour la mise à la terre. Ces deux types de dispositifs ont pour but d'assurer votre sécurité. Si la prise fournie ne s'adapte pas à votre prise de courant, consultez un électricien pour qu'il remplace cette prise obsolète.**
10. Protégez le cordon d'alimentation contre les risques de piétinement ou de pincement, notamment au niveau des fiches, des prises de courant et des branchements à l'appareil.
11. **Utilisez uniquement les accessoires spécifiés par le fabricant.**
12. **Utilisez uniquement le chariot, le support, le trépied, l'équerre ou la table spécifié(e) par le fabricant ou vendu(e) avec l'appareil. Si vous utilisez un chariot, faites attention à ne pas faire basculer l'ensemble chariot/appareil.**



13. Débranchez cet appareil pendant les orages ou en cas d'inutilisation prolongée, afin d'éviter de l'endommager.
14. **Confiez toute réparation à du personnel qualifié. Une réparation est nécessaire lorsque l'appareil a été endommagé de quelque façon que ce soit (endommagement du cordon d'alimentation ou de la fiche électrique, renversement d'un liquide ou de tout objet sur l'appareil, exposition de l'appareil à la pluie ou à l'humidité, mauvais fonctionnement, chute de l'appareil, etc.).** Ne tentez pas de réparer ce produit vous-même. L'ouverture ou la dépose d'un couvercle risque de vous exposer à des tensions électriques ou autres dangers. Veuillez contacter Bose pour connaître les coordonnées du centre de réparation agréé le plus proche.
15. Pour éviter tout risque d'incendie ou d'électrocution, ne surchargez pas les prises murales, les rallonges ou les prises multiples.
16. **Ne laissez jamais d'eau ou d'objets pénétrer à l'intérieur du produit** : des éléments sous tension pourraient être touchés ou il pourrait se produire un court-circuit susceptible d'entraîner un incendie ou un risque d'électrocution.
17. **Consultez les marquages de sécurité sous le boîtier du produit.**
18. **L'écran du panneau d'affichage LCD est illuminé lorsque le produit est alimenté. Si le produit est alimenté et que l'écran LCD n'est pas allumé, veuillez faire réviser l'appareil.**
19. **Veillez à ne pas utiliser l'appareil à une température supérieure à 40 °C. Gardez à l'esprit le fait que la température à l'intérieur d'un rack fermé peut être très supérieure à la température ambiante.**



Ce produit est conforme à toutes les directives de la Communauté Européenne qui s'y appliquent. L'attestation complète de conformité est disponible à l'adresse www.Bose.com/compliance.



Ce produit est conforme à toutes les réglementations de 2016 en matière de compatibilité électromagnétique et à toutes les autres réglementations britanniques applicables. L'attestation complète de conformité est disponible à l'adresse www.Bose.com/compliance



Ce symbole signifie que le produit ne doit pas être jeté avec les déchets ménagers, mais doit être déposé dans un centre de collecte approprié pour recyclage. La mise au rebut adéquate et le recyclage permettent de protéger les ressources naturelles, la santé humaine et l'environnement. Pour plus d'informations sur l'élimination et le recyclage de ce produit, contactez votre mairie, votre service d'enlèvement des ordures ou le magasin où vous avez acheté ce produit.

Ce produit répond aux critères d'immunité des directives EN 55103-2 pour les appareils de classe E2.

Courant d'appel à la mise sous tension : 14,8 A (230 V / 50 Hz)

Courant d'appel après une interruption de 5 secondes de l'alimentation secteur : 15,4 A (230 V / 50 Hz)

Informations sur les produits générateurs de bruit électrique (Notice de conformité FCC pour les USA)

Remarque : ce matériel a fait l'objet de tests prouvant sa conformité aux limites imposées aux appareils numériques de classe A, conformément à la partie 15 des réglementations de la FCC. Ces limites sont conçues pour offrir une protection raisonnable contre les interférences nuisibles lorsque l'appareil est utilisé en environnement commercial. Cet appareil génère, utilise et est susceptible d'émettre de l'énergie à certaines fréquences radio. À ce titre, s'il n'est pas installé ou utilisé conformément aux instructions, il est susceptible de perturber les communications radio. L'utilisation de cet équipement dans une zone résidentielle risque de provoquer des interférences nuisibles, auquel cas l'utilisateur devra remédier au problème à ses propres frais.

Ce produit est conforme aux spécifications CAN ICES-3 (A) /NMB-3 (A).

WARNUNG: Dieses Produkt darf nur von fachkundigen Monteuren installiert werden.

Vielen Dank, dass Sie Bose® PowerMatch®-Verstärker für Ihr Klangverstärkungssystem gewählt haben. Dieses Dokument soll fachkundigen Monteuren grundlegende Installations- und Sicherheitsrichtlinien für Bose PowerMatch-Verstärker in typischen Festinstallationssystemen bieten. Bitte lesen Sie dieses Dokument vor der Installation durch.

WARNUNG: Schützen Sie das Gerät vor tropfenden oder spritzenden Flüssigkeiten, und stellen Sie keine mit Flüssigkeiten gefüllten Gefäße (z. B. Vasen) auf das Gerät oder in die Nähe des Geräts. Wie bei allen elektronischen Geräten dürfen niemals Flüssigkeiten ins Innere gelangen. Dadurch kann es zu Fehlfunktionen und/oder Bränden kommen.

WARNUNG: Um Brände und Stromschläge zu vermeiden, darf dieses Gerät keinem Regen ausgesetzt werden.

WARNUNG: Stellen Sie keine brennenden Kerzen oder ähnliches auf das Gerät oder in die Nähe des Geräts.

WARNUNG: Berühren Sie keine nicht isolierten Kabel oder Kabelklemmen. Die Audiokabelanschlüsse dieses Produkts sind spannungsführend und können Verletzungen verursachen.

Hinweis: Das Produkt ist nicht für den Einsatz im Freien geeignet. Verwenden Sie den Verstärker nur innerhalb von Gebäuden und nicht in Campingfahrzeugen, auf Booten o. ä.

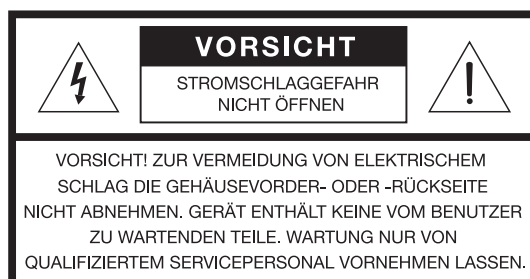

 Das Blitzsymbol mit Pfeilspitze in einem gleichseitigen Dreieck weist den Benutzer auf das Vorhandensein einer nicht isolierten gefährlichen elektrischen Spannung innerhalb des Systemgehäuses hin, durch die die Gefahr von Stromschlägen besteht. Berühren Sie die Ausgangsanschlüsse nicht, wenn der Verstärker eingeschaltet ist. Schalten Sie alle Anschlüsse am Verstärker aus.

 Das Ausrufezeichen in einem gleichseitigen Dreieck, wie es am System angebracht ist, soll den Benutzer auf wichtige Bedienungs- und Wartungsanweisungen in dieser Installationsanleitung aufmerksam machen.

ACHTUNG: Nehmen Sie keine Veränderungen am Verstärker oder am Zubehör vor. Nicht autorisierte Veränderungen können die Sicherheit, die Erfüllung von Richtlinien und die Systemleistung beeinträchtigen.

ACHTUNG: Dieses Produkt muss an eine Steckdose mit Erdungsschutz angeschlossen werden.

ACHTUNG: Falls Sie den Netzstecker verwenden, um das Gerät von der Stromversorgung zu trennen, sollten Sie sicherstellen, dass Sie jederzeit auf den Stecker zugreifen können.

Wichtige Sicherheitshinweise

1. **Lesen Sie die folgenden Anweisungen.**
2. **Bewahren Sie diese Anweisungen auf** – zum späteren Nachschlagen.
3. **Beachten Sie alle Warnhinweise** – am Produkt und in der gesamten Produktdokumentation.
4. **Befolgen Sie alle Anweisungen.**
5. **Verwenden Sie dieses Gerät nicht in der Nähe von Wasser oder Feuchtigkeit.**
6. **Reinigen Sie das Gerät nur mit einem sauberen, trockenen Tuch.**
7. **Achten Sie darauf, dass die Lüftungsöffnungen nicht blockiert sind. Stellen Sie das Gerät nur in Übereinstimmung mit den Herstelleranweisungen auf. Stellen Sie das Gerät an einem Ort auf, an dem gute Ventilation gewährleistet ist, um den zuverlässigen Betrieb des Geräts sicherzustellen und es gegen Überhitzung zu schützen.**
8. **Stellen Sie das Gerät nicht in der Nähe von Wärmequellen auf, wie Heizkörpern, Wärmespeichern, Öfen oder anderen Geräten (auch Verstärkern), die Wärme erzeugen.**
9. **Beeinträchtigen Sie in keiner Weise die Schutzfunktion des Schutzkontaktsteckers. Ein gepolter Stecker hat zwei Stromkontakte, von denen einer breiter als der andere ist. Ein Schutzkontaktstecker hat zwei Stromkontakte und einen dritten Erdungskontakt. Der dritte Kontakt dient der Sicherheit. Falls der mitgelieferte Stecker nicht in Ihre Steckdose passt, wenden Sie sich an einen qualifizierten Elektriker, um die Steckdose auszutauschen.**
10. **Verlegen Sie das Netzkabel so, dass es keine Stolpergefahr darstellt und nicht beschädigt werden kann – insbesondere im Bereich von Steckern und Steckdosen und dort, wo das Netzkabel aus dem Gerät herausgeführt wird.**
11. **Verwenden Sie nur Zubehör-/Anbauteile, die vom Hersteller zugelassen sind.**

12. **Verwenden Sie für das Gerät nur Rollwagen, Ständer, Dreibeine, Halterungen oder Tische, die vom Hersteller zugelassen sind oder zusammen mit dem Gerät verkauft werden. Falls Sie einen Rollwagen verwenden, dürfen Sie die Einheit Gerät/Rollwagen nur mit Vorsicht bewegen, damit Verletzungen beim möglichen Umkippen ausgeschlossen sind.** 
13. Ziehen Sie den Netzstecker des Geräts während eines Gewitters oder wenn Sie das Gerät längere Zeit nicht benutzen – zur Vermeidung von Schäden am Produkt.
14. **Wenden Sie sich bei allen Reparatur- und Wartungsarbeiten nur an qualifiziertes Kundendienstpersonal. Wartungsarbeiten sind in folgenden Fällen nötig: Bei jeglichen Beschädigungen wie z. B. des Netzkabels oder Netzsteckers, wenn Flüssigkeiten oder Gegenstände in das Gehäuse gelangt sind, das Gerät Regen oder Feuchtigkeit ausgesetzt wurde, fallen gelassen wurde oder nicht ordnungsgemäß funktioniert.** Versuchen Sie nicht, dieses Produkt selbst zu warten. Öffnen oder entfernen Sie unter keinen Umständen die Gehäuseabdeckungen, da Sie andernfalls mit gefährlichen elektrischen Spannungen in Berührung kommen oder anderen Gefahren ausgesetzt sein könnten. Wenden Sie sich telefonisch an Bose, um die Anschrift eines autorisierten Kundendienstzentrums in Ihrer Nähe zu erfragen.
15. Vermeiden Sie Gefahren durch Brände oder elektrische Schläge, indem Sie Steckdosen, Verlängerungskabel und integrierte Gerätesteckdosen nicht überlasten.
16. **Lassen Sie keine Flüssigkeiten oder Fremdkörper in das Gerät gelangen** – diese können unter gefährliche elektrische Spannung gesetzt werden oder Bauteile kurzschließen und folglich Brände und Stromschläge auslösen.
17. **Beachten Sie die Sicherheitshinweise auf dem Gehäuse.**
18. **Der LCD-Bildschirm auf der Vorderseite leuchtet, wenn das Produkt Strom erhält. Wenn Strom anliegt und der LCD-Bildschirm nicht leuchtet, geben Sie das Gerät bitte zur Reparatur.**
19. **Achten Sie darauf, dass die Betriebstemperatur des Geräts 40 °C nicht überschreitet. Seien Sie sich aller Bedingungen in einem geschlossenen Rack bewusst, welche zu einem Anstieg der Temperatur über Zimmerniveau führen können.**

 Dieses Produkt entspricht allen Anforderungen der geltenden EU-Richtlinien. Die vollständige Konformitätserklärung ist einsehbar unter www.Bose.com/compliance.

 Dieses Produkt erfüllt alle geltenden Vorschriften zur elektromagnetischen Verträglichkeit 2016 und alle anderen zutreffenden UK-Richtlinien. Die vollständige Konformitätserklärung ist einsehbar unter www.Bose.com/compliance

 Dieses Symbol bedeutet, dass das Produkt nicht mit dem Hausmüll entsorgt werden darf, sondern bei einer geeigneten Sammelstelle für das Recycling abgegeben werden muss. Die ordnungsgemäße Entsorgung und das Recycling tragen dazu bei, die natürlichen Ressourcen, die Gesundheit und die Umwelt zu schützen. Weitere Informationen zur Entsorgung und zum Recycling dieses Produkts erhalten Sie von Ihrer zuständigen Kommune, Ihrem Entsorgungsdienst oder dem Geschäft, in dem Sie dieses Produkt gekauft haben.

Dieses Produkt erfüllt die Anforderungen an die Störfestigkeit der Klasse E2 der Richtlinie EN55103-2.

Anfänglicher Einschaltstrom: 14,8 A (230 V/50 Hz)

Einschaltstrom nach 5 Sekunden Unterbrechung des Netzanschlusses: 15,4 A (230 V/50 Hz)

Informationen über Produkte, die elektrisches Rauschen verursachen (Hinweis zur FCC-Einhaltung für die USA.)

Hinweis: Dieses Gerät wurde geprüft. Es stimmt mit den Regelungen für Geräte der Klasse A gemäß Teil 15 der FCC-Vorschriften überein. Diese Grenzwerte sollen einen angemessenen Schutz gegen elektromagnetische Störungen beim Betrieb in gewerblicher Umgebung gewährleisten. Dieses Gerät erzeugt und verwendet Hochfrequenzstrahlung und kann sie auch aussenden. Daher verursacht das Gerät, wenn die Installation und Benutzung nicht in Übereinstimmung mit dieser Bedienungsanleitung erfolgt, möglicherweise Störungen des Funkverkehrs. Beim Betrieb dieses Geräts in Wohngebieten können erhebliche Störungen des Funkverkehrs verursacht werden. Eventuell daraus entstehende Kosten trägt allein der Benutzer des Geräts.

Dieses Produkt erfüllt CAN ICES-3 (A)/NMB-3 (A).

Introduction.....	11
Product Features.....	11
PowerMatch® Amplifier Line Overview	12
PowerMatch configurable professional power amplifiers	12
Onboard Loudspeaker Processing and Front Panel Interface	12
Accessory Cards	12
Ideal for use with RoomMatch® array module loudspeakers.....	12
Interfacing with ControlSpace® engineered sound processors	12
Controls, Display, and Connectors.....	13
Hardware Installation	14
Unpacking.....	14
Ventilation	14
AC Mains Outlet Requirements	14
Making Connections	15
Connection and Configuration Steps	15
Power (Mains) Connection.....	15
Standby Mode	15
Wiring Input Connectors.....	16
Wiring Output Connectors.....	16
Fault Notification Output	18
Serial over Ethernet	18
Setup and Configuration	19
Configuration Methods.....	19
Control Panel Description.....	20
Front Panel Control Menu Structure.....	21
Control Menu Descriptions.....	21
Setting the Limiting Function for use with 3rd Party Loudspeakers.....	33
Sample Output Configurations for Different Loudspeaker Loads	34
Configuration of a RoomMatch® Two-Module Array (Example 1).....	34
Configuration of a RoomMatch RMS215 Subwoofer Module (Example 2).....	34
Maintenance Operations	35
Updating Firmware and Speaker EQ Presets.....	35
Saving and Recalling Amplifier Settings (USB-only version amplifiers)	36
Saving and Recalling Amplifier Settings (network version amplifiers).....	36
About the Alarm Log and Fault Indicator.....	37
Troubleshooting	38
Appendix.....	39
Interface Comparison Table.....	39
Technical Specifications - Common to all PowerMatch® models.....	40
Technical Specifications - PM8500 / PM8500N	41
Technical Specifications - PM8250 / PM8250N	42
Technical Specifications - PM4500 / PM4500N	43
Technical Specifications - PM4250 / PM4250N	44
AC Current Draw and Thermal Dissipation Information	45

Introduction

Thank you for choosing Bose® PowerMatch® configurable professional power amplifiers.

PowerMatch® power amplifiers deliver concert-quality sound for a wide variety of fixed-installation sound reinforcement systems and provide class-leading efficiency, sound quality, and reliability.

Two documents are available to assist with amplifier installation and configuration. This document delivers detailed installation and standalone configuration information. A separate document, the ControlSpace® Designer™ Software Guide (downloadable from pro.Bose.com), provides detailed instructions on how to use ControlSpace Designer software to fully configure, monitor, and update PowerMatch amplifiers. For network version amplifiers, Designer software provides additional network setup, control, and monitoring capabilities.

Information furnished in these guides is intended to help professionals install and set up the product, but does not include all details of design, production, or variations of equipment. Nor does it cover every possible situation that may arise during installation, operation, or maintenance. If assistance is required beyond the scope of these documents, please contact your local Bose Representative or Technical Support specialist.

Product Features

- **PowerMatch amplifier series**

Four amplifier models provide multiple channel and power options to satisfy the needs of almost any audio installation. Models include options for 4 or 8 channel versions and 250 or 500 watt per channel power levels. Additionally, network versions add control and monitoring functionality over standard Ethernet networks.

- **Dual Feedback Loop System**

Proprietary design combines Class-D efficiency with a dual current and voltage feedback loop circuit that continuously monitors and controls both the current and voltage delivered to the loudspeaker load. This combination allows the amplifier to consistently deliver the widest possible dynamic range, frequency response, and lowest possible distortion, independent of power level and load impedance.

- **QuadBridge™ Output Configuration**

Each loudspeaker output terminal can be configured as Mono, V-Bridge, I-Share or Quad, allowing the total available power of the amplifier bank to be allocated to one or more output channels. V-Bridge and Quad modes can drive either low-impedance or 70/100V loads. Configuration of the loudspeaker output can be accessed from either the front panel of the amplifier or using ControlSpace Designer software.

- **PeakBank™ Power Supply**

Regenerative 4-quadrant power supply with fast-tracking Power Factor Correction (PFC) supports high efficiency while delivering sustainable and repeatable low frequency response.

- **Integrated DSP**

A configurable fixed-architecture DSP provides multiple EQ stages, crossovers, delays, limiters, and matrix mixing. While PowerMatch can drive nearly any loudspeaker for the installed sound market, pre-loaded loudspeaker EQs and limiting presets for Bose loudspeakers provide an additional layer of simplified setup and premium sound. Amplifier models PM8500 and PM4500 feature power levels and array EQ features ideal for use with RoomMatch® array module loudspeakers and subwoofers.

- **ControlSpace® Designer™ Software Setup**

All models offer front panel USB connectivity for Bose ControlSpace Designer software programming, with network versions adding Ethernet network setup, control, and monitoring.

- **Front Panel User Interface**

Combined front panel LCD and user controls provide useful visual information and access to a subset of amplifier settings sufficient for basic amplifier output configuration and status/fault monitoring. A convenient panel lock can be set to prevent access to unauthorized users.

- **Network Control and Monitoring**

Network versions support a set of remote monitoring and fault reporting capabilities via the rear panel RJ45 Ethernet connection and Bose ControlSpace Designer software. A fault reporting and control protocol using Serial over Ethernet allows third party control and monitoring systems to communicate easily with one or many PowerMatch amplifiers.

- **Load Sweep Tool**

Using ControlSpace Designer software, the amplifier can measure the load impedance of each low impedance-configured output for system diagnostic and documentation purposes. The load measurement can be stored inside the amplifier and recalled as a reference curve for future comparisons to determine if the system is still operating as expected.

- **Digital Expansion Slot**

Optional digital cards expand the input capabilities of PowerMatch® amplifiers, enabling the amplifiers to receive digital audio from Bose ESPLink-equipped devices and popular digital audio networks.

- **Auto-Standby / Auto-Wake**

Energy saving feature that allows PowerMatch amplifiers to automatically go into a lower power Standby Mode when audio signal falls below a set threshold, and wake up when audio signal is above threshold. All parameters, including time and audio detection levels are adjustable from within ControlSpace® Designer™ software.

PowerMatch® Amplifier Line Overview

PowerMatch configurable professional power amplifiers

PowerMatch multi-channel power amplifiers are highly efficient, reliable and configurable. Four amplifier models provide channel and power options for most fixed-installation audio systems. Each model offers front panel USB connectivity for full access to settings using ControlSpace® Designer™ software. Network versions of each amplifier feature a rear panel RJ45 connector, allowing network setup, control, and remote monitoring of one or more PowerMatch amplifiers using ControlSpace Designer software and standard network equipment.

Onboard Loudspeaker Processing and Front Panel Interface

All amplifier models share the same onboard loudspeaker processing and front panel interface but vary in channel count, power, and Ethernet connectivity.

The following table summarizes the key differences between the PowerMatch amplifier models:

PowerMatch Amplifier Models	Total Rated Power	Channels (max.)	Output Connectors	Recommended AC Mains Circuit	IEC Power Cord
PM8500 / PM8500N	4000 watts	8	2	20A (120 V) or 16A (230 V)	C19
PM8250 / PM8250N	2000 watts	8	2	15A (120 V) or 10A (230 V)	C13
PM4500 / PM4500N	2000 watts	4	1	15A (120 V) or 10A (230 V)	C13
PM4250 / PM4250N	1000 watts	4	1	15A (120 V) or 10A (230 V)	C13

Accessory Cards

PowerMatch amplifiers feature a digital expansion slot for accessory plug-in cards. These cards allow for added I/O flexibility. For example, the Bose® PM ESPLink card provides a shared 8-channel uncompressed digital audio bus between one or more PowerMatch units and a ControlSpace ESP engineered sound processor. Visit pro.Bose.com for additional information and to view the latest list of PowerMatch accessory cards.

Accessory Card	Product Code
PowerMatch Dante™ network card	PC 359844-0020
PowerMatch CobraNet® card	PC 345975-0110
PowerMatch ESPLink digital input card	PC 349898-0110
PowerMatch AES3 input card	PC 638301-0010

Ideal for use with RoomMatch® array module loudspeakers

RoomMatch loudspeakers connect and configure easily to PM8500 and PM4500 amplifiers. Built-in loudspeaker and array EQs together with suitable output power ratings and optimized loudspeaker limiting/protection make these amplifiers ideal for use in designs with RoomMatch array module loudspeakers.

Interfacing with ControlSpace® engineered sound processors

PowerMatch amplifiers are designed to be used independently or in any system with most professional audio processing equipment and loudspeakers. However, there are unique advantages to using PowerMatch with Bose ControlSpace ESP engineered sound processors. These processors enable multi-channel input options, mixing, routing, processing, and distribution capabilities – all using a single configuration tool, ControlSpace Designer software.

Using a Bose ESPLink connection, a ControlSpace ESP engineered sound processor can route 8 digital audio channels to multiple PowerMatch amplifiers for low latency in-rack audio distribution. For wiring digital audio between racks or for use in larger distributed systems, Audio over Ethernet expansion cards are also available for use with the PowerMatch and ControlSpace ESP processors.

Controls, Display, and Connectors

Figures 1 and 2 detail the various elements found on the front and rear panels of PowerMatch® amplifiers.

Figure 1. Front Panel View

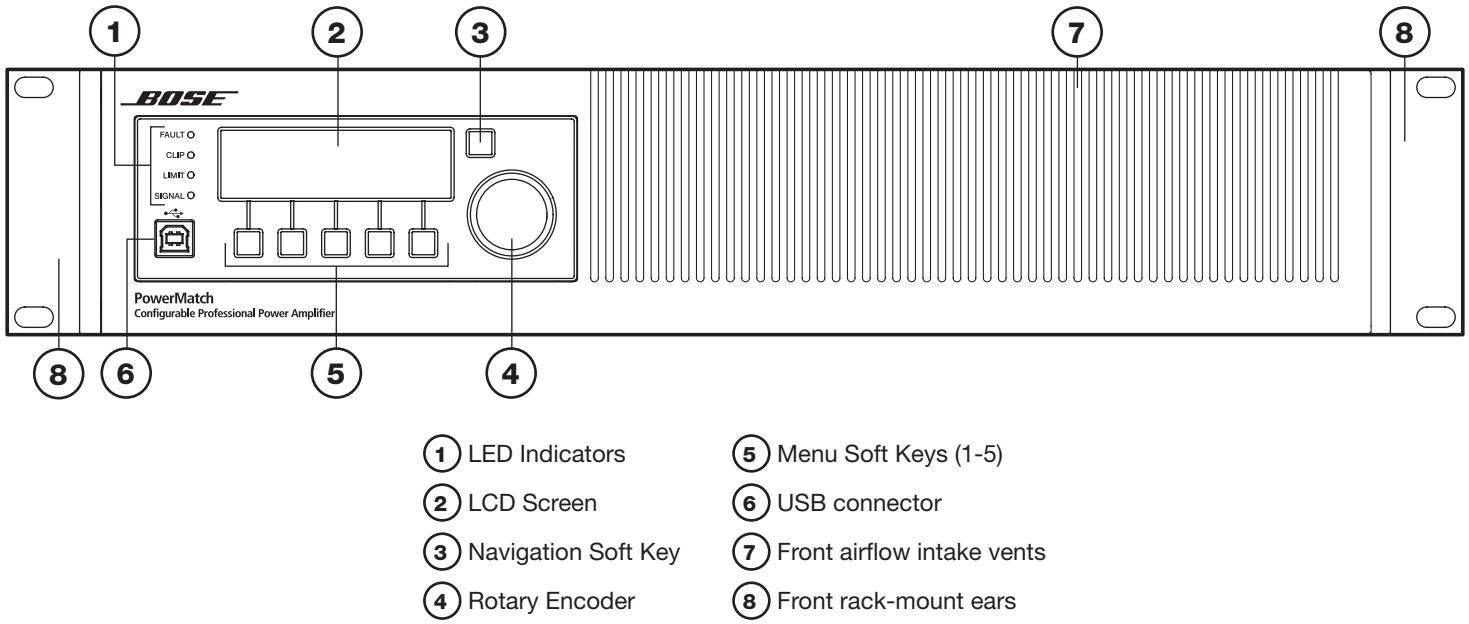

- ① LED Indicators
- ② LCD Screen
- ③ Navigation Soft Key
- ④ Rotary Encoder
- ⑤ Menu Soft Keys (1-5)
- ⑥ USB connector
- ⑦ Front airflow intake vents
- ⑧ Front rack-mount ears

Figure 2. 4-channel and 8-channel Rear Panel Views

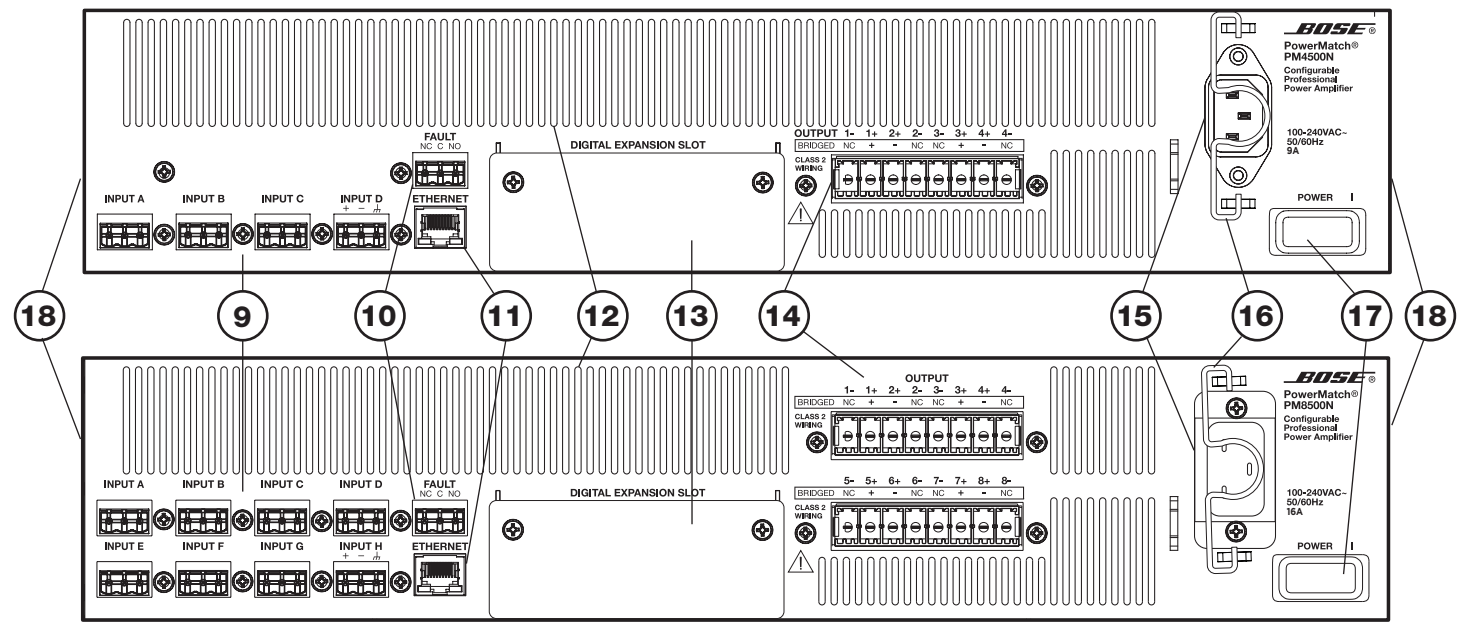

- ⑨ Analog Input connectors
- ⑩ Fault Notification Output
- ⑪ Ethernet RJ-45 network connector (Network versions only)
- ⑫ Rear airflow exhaust vents
- ⑬ Digital expansion card slot cover
- ⑭ Loudspeaker output connectors
- ⑮ AC Mains receptacle
- ⑯ AC Mains retention clip
- ⑰ Power Switch/Resettable Circuit Breaker
- ⑱ Rear rack-mount support tabs

Hardware Installation

Unpacking

The product carton includes the following items:

Figure 3. Carton contents

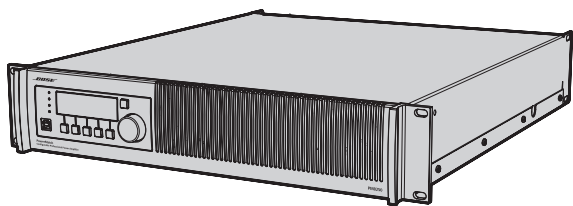

PowerMatch® amplifier



Installation and Operating Guide

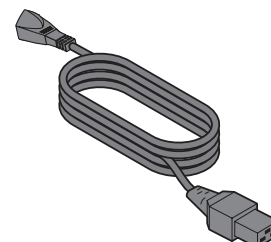

Detachable IEC power cord

Connector Accessory Pack (contents vary according to model number):

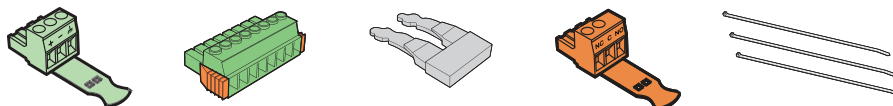

PowerMatch models	Input connectors	Output connectors	Shorting jumpers	Fault connector	Plastic wire tie-wraps	Accessory Kit PN
PM8500, PM8500N	8	2	4	1	9	343511-0010
PM8250, PM8250N						
PM4500, PM4500N	4	1	2	1	5	343511-0020
PM4250, PM4250N						

Rack Mounting

PowerMatch amplifiers are designed to fit standard 19-inch (48 cm) rack equipment, occupying 2 rack-units (RU) in height, requiring a mounting depth of 21 inches (53 cm) from the front rack rail. Use four fasteners with washers (not supplied) to mount the amplifier front panel rack ears to the equipment rack rails. Rack-mount tabs are also provided on the rear of the chassis to secure the amplifier using rear rack mount ears (not provided). Rear rack mounting is recommended in cases when pre-assembled racks with amplifiers are transported to installation venues.

Ventilation

PowerMatch amplifiers are designed to operate under a wide range of conditions, with continuous operation up to 104° F (40° C) ambient temperature. To ensure safe operation, the front and rear airflow vents should never be blocked. Air flows into the front of the unit and exits the rear vents. The internal fans automatically increase speed when the amplifier is generating more heat. Should the unit exceed safe operating temperature, a gradual reduction of gain will automatically be applied for thermal protection. If the automatic gain reduction does not reduce operating temperatures to safe conditions, the unit will mute all outputs and the red **FAULT** LED will illuminate on the front panel.

AC Mains Outlet Requirements

PowerMatch amplifiers feature an efficient, universal switch-mode power supply with fast-tracking Power Factor Correction (PFC) and can operate with AC mains line voltages from 100 to 240 volts at 50/60 Hz. With typical music program material, amplifier model PM8500 provides full rated power from a single 20-amp, 120V (common in USA) AC mains outlet, or single 16-amp, 230V (common in Europe) mains outlet. The mains circuit requirement for models PM8250, PM4500, and PM4250 is lesser, as full rated power can be achieved using a 15-amp, 120V (USA) AC mains outlet or a 10-amp, 230V (Europe) AC mains outlet.

High-power amplifiers draw large amounts of current from the AC mains. Use of extension cords to power the amplifier could introduce significant impedance and a resulting voltage drop on the mains that may interfere with normal operation of the amplifier.

In countries like Japan where 100V AC mains are used, the following guidelines will be helpful to ensure optimal performance:

- Ensure a minimum of 100V AC at the amplifier plug when the amplifier is idle.
- Use a dedicated mains circuit for each amplifier.
- Locate the amplifiers as close as possible to the mains outlet.
- If used, extension cords should be 14 AWG (2 mm²) or larger, and less than 6.6 ft (2 m) in length.

Making Connections

Connection and Configuration Steps

Use the following procedure when setting up a PowerMatch® amplifier for the first time.

1. Install any digital expansion cards (optional)
2. Mount the amplifier into the rack
3. Connect power cable and retaining clip
4. Turn on amplifier
5. Enable Standby Mode from the front panel of the amplifier (See page 29.)
6. Configure amplifier (use front panel or ControlSpace® Designer™ software)
7. Wire input connection from source device(s)
8. Wire output connectors to speakers
9. Disable Standby Mode
10. Connect Fault Notification Output to management system or device (optional)
11. Clear alarms (See page 30.)
12. Test system

Power (Mains) Connection

Power connection is made using the included IEC power cord. The amplifier also includes a retaining clip to help secure the power connection to the amplifier. To install, place the retaining clip toward the center of the amplifier, plug in the IEC power cord, then swing the retaining clip so it locks behind the IEC connector.

Figure 4. IEC Connector retaining clip in place.

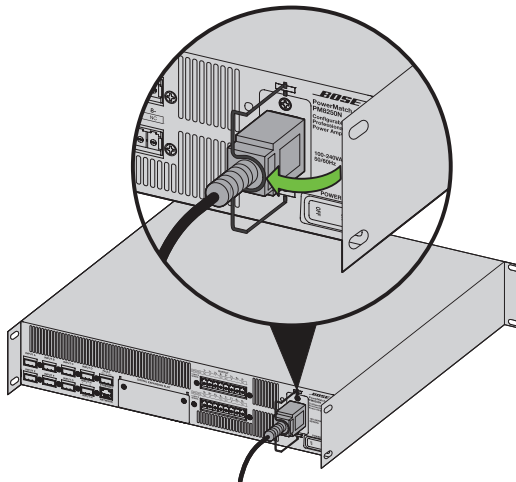

Standby Mode

Enabling Standby Mode decouples the amplifier section from the loudspeaker output. In this state the product also consumes less power. Standby Mode can be entered manually from the front panel using the following steps:

MAIN MENU > UTILITY > STANDBY MODE > press ENTER STANDBY

While in Standby, front panel options and loudspeaker output configurations can be changed without directly affecting the loudspeaker load.

Standby Mode can be automatically entered and exited using the Auto-Standby/Auto-Wake function as a method to help reduce energy usage during times when audio is not required. Refer to the ControlSpace Designer Software Guide for details on this feature.

Wiring Input Connectors

The balanced line-level analog inputs utilize 3-pin terminal block connectors (Phoenix Contact® #1776168, supplied). Terminal descriptions are printed directly on the connectors for convenience. For balanced inputs, strip the wire ¼ inch (6 mm) and connect to the respective positive, negative, and ground terminals as indicated on the connector and in Figure 5. Tinned wires are not recommended. For unbalanced inputs, the connector should be wired with the negative and ground/shield terminals, connected with a jumper wire (not supplied). To reduce the occurrence of ground loop noise, it is recommended that the input cable shield be joined with the ground terminal at only one device - at the source output connector or at the amplifier input connector. You can use the supplied tie-wraps to help secure the input cables.

Figure 5. Balanced and unbalanced connectors (jumper not supplied)

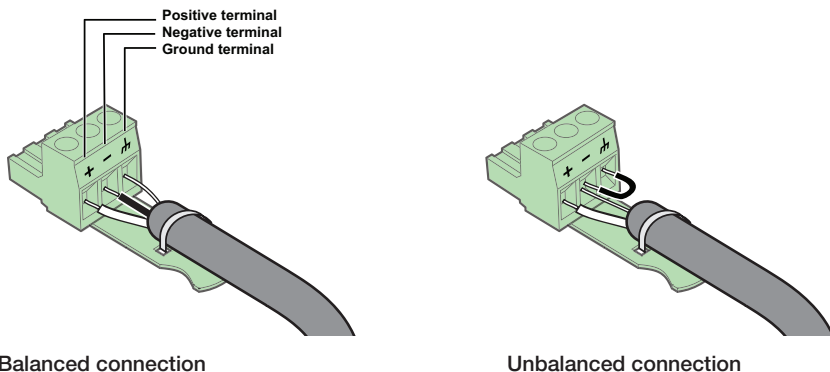

Wiring Output Connectors

PowerMatch® amplifiers feature QuadBridge™ technology which provides the flexibility to reconfigure each amplifier output. On a single output connector, amplifier power can be allocated between 1 and 4 output channels for low impedance loudspeaker loads or up to 2 output channels for high impedance (70V and 100V) loudspeaker loads. A combination of high/low impedance loads and a mix of power levels can be configured through the front panel interface or using ControlSpace® Designer™ software. The following table describes the behavior of the four available output modes:

Mode	Description
Mono	Each channel operates independently, and will drive 2 to 16 Ω loads
V-Bridge	Channel pairs are combined to deliver 2x voltage and will drive high impedance (70V or 100V) and 4 to 8 Ω loads
I-Share	Channel pairs are combined to deliver 2x current, and will drive 2 Ω loads
Quad	Two channel pairs are combined to deliver 2x voltage and 2x current while driving high impedance (70V or 100V) or 4 Ω loads

4-channel amplifiers (PM4500, PM4250) use a single loudspeaker output connector. 8-channel amplifiers (PM8500, PM8250) split total amplifier power across two output connectors. In the case of the PM8500 which has a maximum rated power of 4000 watts, power is split where 2000 watts is available at each output connector.

Each loudspeaker output utilizes a high-current, 8-pin locking terminal block connector (Phoenix Contact® COMBICON® Part #1778120, supplied) that accept cables from 10 to 24 AWG (5.3 - 0.2 mm²) in diameter.

Note: Use Class 2 wiring for speaker connections.

To wire the output connector:

1. Strip the insulation off each speaker wire to expose 3/8" (10 mm) of bare conductor.
2. Insert each wire into the correct terminal on the block connector. Use a small Phillips size 1 (or appropriate) screwdriver to secure the wire.
3. Firmly press the block connector into the receptacle on the amplifier until the left and right latches snap into place.

To detach the block connector from the amplifier, slide the two orange release tabs **toward** the amplifier to release the locking tabs. Once released, pull the terminal block connector from the amplifier.

Warning: While the amplifier does self-protect under most improper output conditions, misconfiguration of loudspeaker mode and incorrect connection of loudspeakers could damage connected loudspeakers and/or amplifier.

The following chart shows examples of the types of loads possible with the required output mode:

Loudspeaker Load	Output Mode	Channel Sharing	PM8500	PM8250	PM4500	PM4250
2 - 8 Ω	Mono (Low-Z)	None	500 W @ 4 Ω	250 W @ 4 Ω	500 W @ 4 Ω	250 W @ 4 Ω
4 - 8 Ω	V-Bridge (Low-Z)	Half block	1000 W @ 8 Ω	500 W @ 8 Ω	1000 W @ 8 Ω	500 W @ 8 Ω
70V	V-Bridge (70V)	Half block	800 W @ 70V	400 W @ 70V	800 W @ 70V	400 W @ 70V
100V	V-Bridge (100V)	Half block	1000 W @ 100V	500 W @ 100V	1000 W @ 100V	500 W @ 100V
2 Ω, high power	I-Share (Low-Z)	Half block	1000 W @ 2 Ω	500 W @ 2 Ω	1000 W @ 2 Ω	500 W @ 2 Ω
4 Ω, high power	Quad (Low-Z)	Full block	2000 W @ 4 Ω	1000 W @ 4 Ω	2000 W @ 4 Ω	1000 W @ 4 Ω
70V, high power	Quad (70V)	Full block	1600 W @ 70V	800 W @ 70V	1600 W @ 70V	800 W @ 70V
100V, high power	Quad (100V)	Full block	2000 W @ 100V	1000 W @ 100V	2000 W @ 100V	1000 W @ 100V

Note: Configure the output mode of the amplifier before connecting loudspeakers. See page 21 for details on front panel configuration. Carefully follow the proper connection method for the selected output configuration.

The wiring of the connector varies by amplifier output configuration. The output terminal assignments for Mono (single channel) and V-Bridge configurations are printed on the rear panel of the amplifier.

The following graphics illustrate wiring examples for the different output configuration modes. Mixed combinations of Mono, V-Bridge, and I-Share modes are possible from one output block.

Figure 6. Output wiring showing the four basic configurations

Mono mode

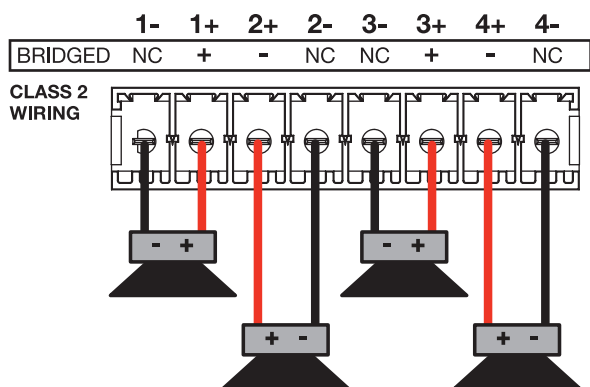

V-Bridge mode

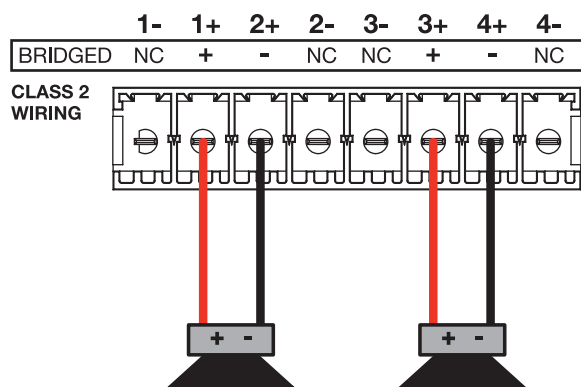

I-Share mode

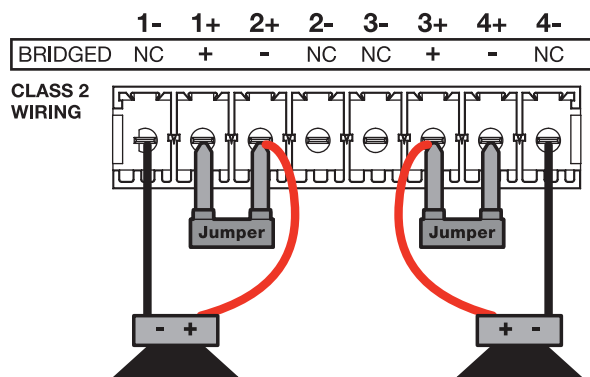

Quad mode

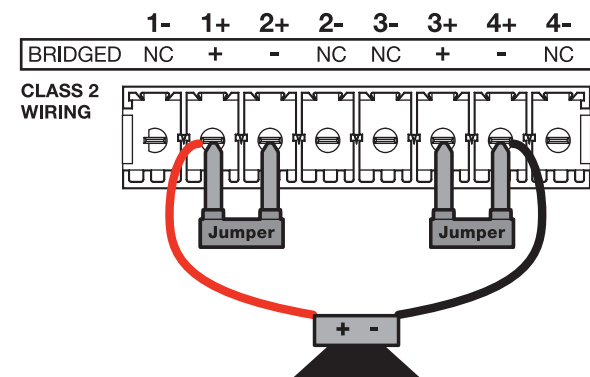

Note: Changing the output configuration may automatically place the unit in Standby Mode to allow the safe installation of loudspeaker cable connections to the rear panel output terminal blocks.

Note: While not optimal, a 70/100V loudspeaker load can be driven off a single channel in Mono mode but is limited to 50 V RMS / 71 V Peak capability. Download the application note "Using Mono Mode to Drive High Impedance Loudspeaker Loads" from pro.Bose.com for details on how to adjust software and tap settings for this derated use.

Fault Notification Output

Each PowerMatch amplifier features a hardware fault notification circuit. This circuit drives a normally open or normally closed contact closure (1A, 30 VDC maximum). The fault output, using the orange-colored 3-pin terminal block (Phoenix Contact® #1976010, supplied), is intended to provide an external connection to a remote system monitor for fault notification purposes. Terminal assignments are printed directly on the connector as shown in Figure 7. See “About the Alarm Log and Fault Indicator” on page 37 for details on trapped faults and how to filter reported faults.

Figure 7. Fault Notification output connector

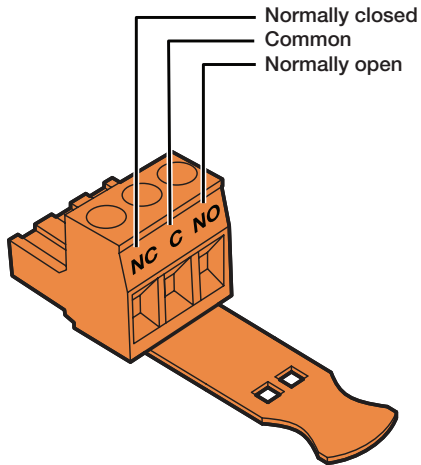

Serial over Ethernet

Network version amplifiers can leverage the Ethernet connector to communicate serial data with control systems and devices. Commands are available to read and set Standby Mode status, and to read the output configuration. For interfacing with third party control systems, the amplifier is also able to read and set the amplifier to broadcast alarms, fault events, and changes to the Fault Output state when they occur.

A full listing of the available protocol can be found in the PDF document "ControlSpace® Serial Control Protocol" on pro.Bose.com.

Setup and Configuration

Figure 8 shows the basic signal flow and available DSP functions available to manipulate each individual input channel.

Some functions and advanced parameters can only be modified using ControlSpace® Designer™ software. See “Interface Comparison Table” on page 39 to view configurations required to access functions and features.

Figure 8. Simplified DSP block diagram (8-channel diagram shown; 4-channel models are similar)

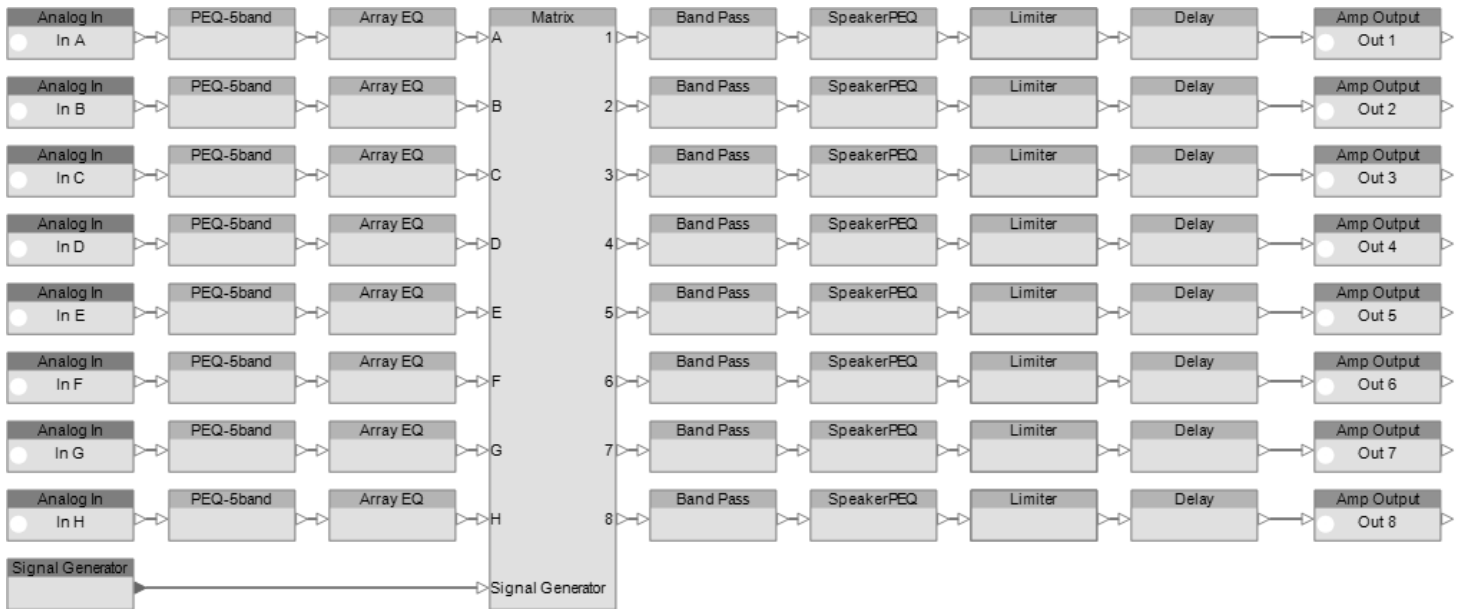

Configuration Methods

There are three methods to configure a PowerMatch® amplifier for use. The table below shows those methods and describes functionality differences between the methods.

Method of Configuration	Use Case
Local front panel	Fast, easy access to status, basic loudspeaker processing and control options.
USB connection to ControlSpace Designer software	<ul style="list-style-type: none"> • Full-featured control and visibility over all DSP functions. • Graphical tools available to help create EQs for 3rd party loudspeakers, real time display and monitoring. • Multiple network version amplifiers can be configured and monitored from a single PC using an RJ45 Ethernet connection (use shielded CAT5e cable only).
RJ45 connection to ControlSpace Designer software (network versions only)	

Control Panel Description

Figure 9. PowerMatch® Front Panel

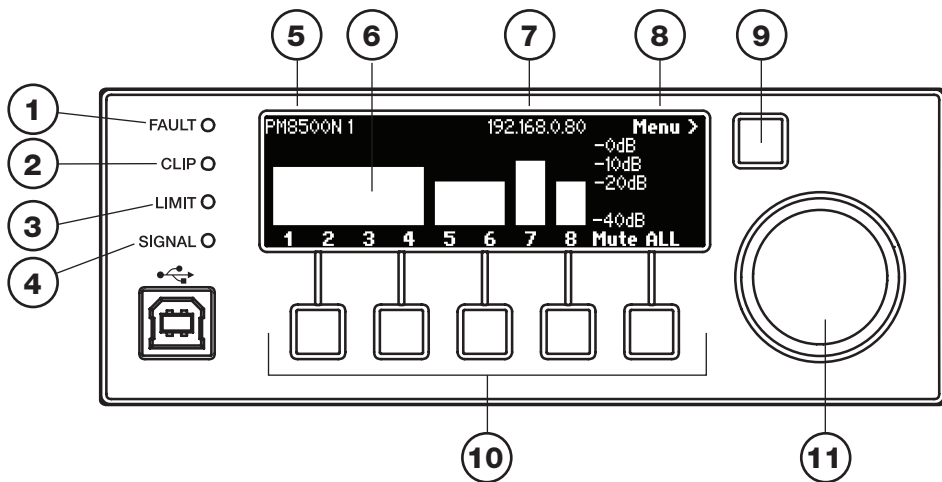

①	Fault LED Indicator	LED lights red when a fault condition has been detected. For more information see Figure 18, "Fault Conditions" on page 37.
②	Clip LED Indicator	Indicates red when the input signal reaches full scale. Bose recommends that you reduce input levels or modify input sensitivity settings to prevent this condition. (See Input Sensitivity on Page 24).
③	Limit LED Indicator	When this LED illuminates, indicates that one or more output channels have reached user-adjustable RMS or Peak threshold values or that system internal protection is occurring.
④	Signal LED Indicator	Flashes with the presence of input signal.
⑤	Hardware Name / Menu Depth	Displays the name (either default or assigned) given to this amplifier. This can be changed using ControlSpace® Designer™ software. While navigating menus, indicates current menu location and depth.
⑥	Meters	While at the operating screen (shown), each channel shows the status and level of its output. Muted channels show MUTE in the bar and combined channel modes show grouped bars as shown above with channels 1-4 and channels 5-6. Output meters automatically change display width to correspond to the active output configuration.
⑦	IP Address / Device ID	Shows the IP address (network versions only) or device ID number (USB-only models). Setting can be modified using ControlSpace Designer software.
⑧	Navigation Indicator	Indicates which menu level will be actuated when the Navigation Soft Key is pressed.
⑨	Navigation Soft Key	Actuates the menu level as indicated by the Navigation Indicator.
⑩	Menu Soft Keys (1-5)	Selects various options that appear on the LCD screen directly above these controls.
⑪	Rotary Encoder	This spin/press control wheel allows scrolling and selection of items shown in lists.

Front Panel Control Menu Structure

The displays and user controls accessible by the front panel are presented in the following menu structure illustration:

Figure 10. Front panel menu structure

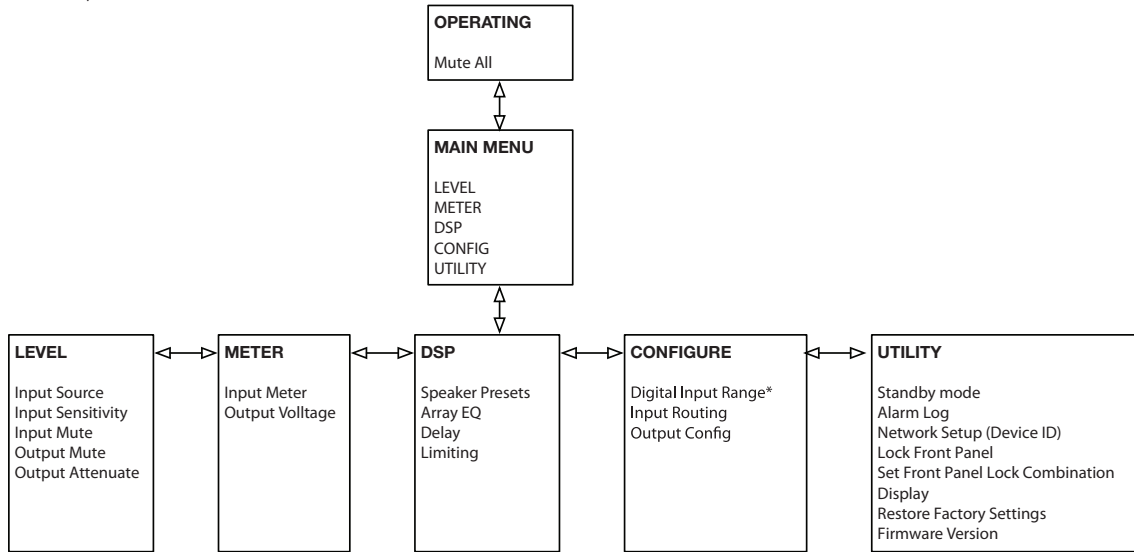





* PM4500 and PM4250 models only

Control Menu Descriptions

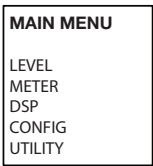
The following tables describe each menu item and the various options available to the user from the front panel. Front panel screens from the PM8500N amplifier are shown which are indicative of both the PM8500 and PM8250 models. Models PM4500 and PM4250 screens will be similar and simplified over the 8-channel models.

OPERATING	
Description	This is the default operating display for the amplifier. Shows the amplifier name, IP Address/ Device ID and current output configuration. In this case, channels 1-4 are running in Quad mode, channels 5 and 6 are in V-Bridge (or I-Share mode), and channels 7 and 8 are running independently in Mono modes. The level shown is -40dB to 0dB full scale.
Available Controls	Navigation Soft Key: Enters MAIN MENU. Menu Soft Key #5: Mutes/Unmutes ALL output channels.

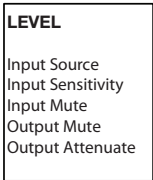
MAIN MENU	
	
Description	The MAIN MENU offers five areas of control: <ul style="list-style-type: none"> • Level • Meter • DSP • Configuration • Utility
Available Controls	Navigation Soft Key: Back to OPERATING display. <ul style="list-style-type: none"> • Menu Soft Key #1: Enters LEVEL menu. • Menu Soft Key #2: Enters METER Menu. • Menu Soft Key #3: Enters DSP Menu. • Menu Soft Key #4: Enters CONFIG Menu. • Menu Soft Key #5: Enters UTILITY Menu.
Notes	Network version amplifiers have the option to select the mode of "Power Up" state, whether to restore last settings or revert to project file settings on power up. Selectable from the amplifier properties page in ControlSpace® Designer™ software, the "Restore Last Settings" state is disabled by default for network version amplifiers. Due to the standalone nature of USB-only amplifiers, front panel changes are usually intentional and should be recalled on subsequent power-ups.

MAIN MENU < LEVEL	
	
Description	The LEVEL menu allows access to the input and output level and type parameters.
Available Controls	Navigation Soft Key: Back to MAIN MENU. Menu Soft Key #1-5: Changes menu to respective category. Rotary Encoder: Scrolls and selects menu options.
Options	Input Source Input Sensitivity Input Mute Output Mute Output Attenuate

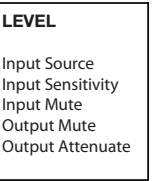
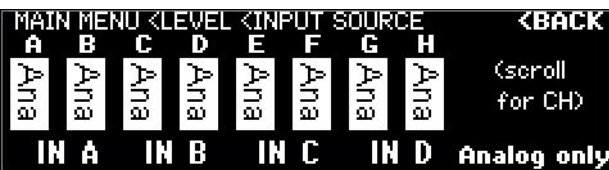
MAIN MENU < LEVEL < INPUT SOURCE	
	
Description	This display allows you to select an analog or digital audio source for each input channel. No parameters can be modified if the amplifier is without a digital input card.
Available Controls	To access Input Source, use the rotary encoder dial from the LEVEL menu to highlight, then press to select. Navigation Soft Key: Back to LEVEL menu. Rotary Encoder: On 8-channel models, allows the scrolling of two pages of four input channels. Menu Soft Key #5: Toggles between forcing all channels to be Analog and all channels to be Digital. For amplifiers without an input card installed, the inactive button caption reads "Analog only." Menu Soft Key #1-4: Toggle between input type analog or digital for each displayed channel.
Options	"Ana" (Analog), "Dig" (Digital).
Notes	Options only available when a digital expansion card is installed.

MAIN MENU < LEVEL < INPUT SENS	
<div style="border: 1px solid black; padding: 5px; width: fit-content;"> <p>LEVEL</p> <p>Input Source Input Sensitivity Input Mute Output Mute Output Attenuate</p> </div> <p>→</p>	
Description	<p>This display allows you to appropriately match each configured input channel to the incoming signal. This per channel setting corresponds to the level that will create rated power out of the amplifier, with all other gains through the DSP signal processing chain set to 0 dB (unity gain). For best noise performance use the highest setting you can, keeping peaks of the input signal as close to the sensitivity level as you can without exceeding it.</p> <p>Real-time output is displayed and affected by changing the sensitivity level.</p>
Available Controls	<p>To access <i>Input Sensitivity</i>, use the rotary encoder dial from the LEVEL menu to highlight, then press to select.</p> <p>Navigation Soft Key: Back to LEVEL menu.</p> <p>Menu Soft Key #5: Enables the scrolling of four pages of two input channels using the rotary encoder.</p> <p>Menu Soft Key #1 and #3: Enables the respective input channel to be selected. Use the rotary encoder to select sensitivity values in dBu.</p>
Options	+0.0 dBu, +4.0dBu, +12dBu, +24dBu



MAIN MENU < LEVEL < INPUT MUTE	
<div style="border: 1px solid black; padding: 5px; width: fit-content;"> <p>LEVEL</p> <p>Input Source Input Sensitivity Input Mute Output Mute Output Attenuate</p> </div> <p>→</p>	
Description	This display allows you to mute each input channel.
Available Controls	<p>To access <i>Input Mute</i>, use the rotary encoder dial from the LEVEL menu to highlight, then press to select.</p> <p>Navigation Soft Key: Back to LEVEL menu.</p> <p>Rotary Encoder: Continuously scrolls through two input channel pages, allowing users to access Input A-D, and on 8-channel models, Input E-H.</p> <p>Menu Soft Key #1-4: Toggles the mute state for each channel listed above each button.</p> <p>Menu Soft Key #5: Enables/disables muting of all channels.</p>
Options	Mute enabled/disabled per channel. Mute ALL enabled/disabled for all channels.
Notes	All input channels can also be muted from the MAIN MENU < METER < INPUT display.

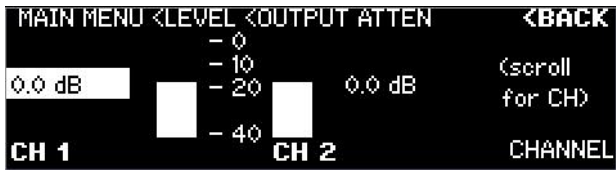

MAIN MENU < LEVEL < OUTPUT MUTE	
<div style="border: 1px solid black; padding: 5px; width: fit-content;"> <p>LEVEL</p> <p>Input Source Input Sensitivity Input Mute Output Mute Output Attenuate</p> </div> <p>→</p>	
Description	This display allows each configured output channel to be muted. For channels set to output modes other than Mono, as in the case shown with channels 1-4 above, muting control is bound by the configured groupings.
Available Controls	<p>To access <i>Output Mute</i>, use the rotary encoder dial from the LEVEL menu to highlight, then press to select.</p> <p>Navigation Soft Key: Back to LEVEL MENU.</p> <p>Rotary Encoder: Scrolls through output channels as displayed under the eight indicator boxes (8-channel models only).</p> <p>Menu Soft Key #1-4: Toggles the mute state for each channel listed above each button. Note that some keys may not have channels listed.</p> <p>Menu Soft Key #5: Enables/disables muting of all channels.</p>
Options	Mute enabled/disabled per channel. Mute ALL enabled/disabled for all channels.
Notes	Output channels can also be (all) muted from the MAIN MENU and MAIN MENU < METER < OUTPUT VOLTS screens.

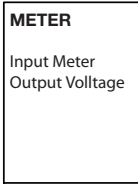

MAIN MENU < LEVEL < OUTPUT ATTEN	
<div style="border: 1px solid black; padding: 5px;"> <p>LEVEL</p> <ul style="list-style-type: none"> Input Source Input Sensitivity Input Mute Output Mute Output Attenuate </div>	
<p>Description</p>	<p>This display allows you to attenuate each configured output channel. For channels set to output modes other than Mono, attenuation control is bound by the configured groupings. Two output channels are displayed at one time. Real time output is displayed and affected by changing attenuation.</p>
<p>Available Controls</p>	<p>To access <i>Output Atten</i>, use the rotary encoder dial from the <i>LEVEL</i> menu to highlight, then press to select.</p> <p>Navigation Soft Key: Back to <i>LEVEL</i> menu.</p> <p>Menu Soft Key #5: Enables channel navigation using the rotary encoder.</p> <p>Menu Soft Key #1 and #3: Enables the respective output channel to be selected. Use the rotary encoder to select attenuation values in dB.</p>
<p>Options</p>	<p>-60dB to 0dB in increments of 0.5dB.</p>

MAIN MENU < METER	
<div style="border: 1px solid black; padding: 5px;"> <p>METER</p> <ul style="list-style-type: none"> Input Meter Output Voltage </div>	
<p>Description</p>	<p>The <i>METER</i> menu allows you to view the status of both input and output channels.</p>
<p>Available Controls</p>	<p>Navigation Soft Key: Back to <i>LEVEL</i> menu.</p> <p>Menu Soft Key #1-5: Changes menu to respective category.</p> <p>Rotary Encoder: Scrolls and selects menu options.</p>
<p>Options</p>	<p>Output Voltage Input Meter</p>

MAIN MENU < METER < INPUT	
<div style="border: 1px solid black; padding: 5px;"> <p>METER</p> <ul style="list-style-type: none"> Input Meter Output Voltage </div>	
<p>Description</p>	<p>This display allows you to monitor each input channel. You can also mute all input channels.</p>
<p>Available Controls</p>	<p>To access the <i>Input Meter</i>, use the rotary encoder dial from the <i>METER</i> menu to highlight, then press to select.</p> <p>Navigation Soft Key: Back to <i>METER</i> menu.</p> <p>Menu Soft Key #5: Enables/disables muting of all output channels.</p>
<p>Options</p>	<p>Mute ALL, Unmute ALL.</p>



MAIN MENU < METER < OUTPUT VOLTS	
	
Description	This display allows you to monitor each configured output channel voltage. For channels set to output modes other than Mono, metering is bound by the configured groupings. You can also mute all output channels.
Available Controls	To access Output Voltage, use the rotary encoder dial from the METER menu to highlight, then press to select. Navigation Soft Key: Back to METER menu. Menu Soft Key #5: Enables/disables muting of all output channels.
Options	Mute ALL, Unmute ALL.



MAIN MENU < DSP	
	
Description	The DSP menu allows you to apply sophisticated digital signal processing to the signal chain.
Available Controls	Navigation Soft Key: Back to MAIN MENU. Menu Soft Key #1-5: Changes menu to respective category. Rotary Encoder: Scrolls and selects menu options.
Options	Speaker Presets Array EQ Delay Limiting
Notes	Further DSP functions and product features are available using ControlSpace® Designer™ software. See "Interface Comparison Table" on page 26 for the complete list of available functionality.



MAIN MENU < DSP < SPEAKER PRESETS	
	
Description	This display allows you to apply Bose® loudspeaker preset EQs to each amplifier output. Scroll bars for speaker series and speaker families help indicate the relative position of the current selection in each list.
Available Controls	To access the Speaker Presets, use the rotary encoder dial from the DSP menu to highlight, then press to select. Navigation Soft Key: Back to DSP menu. Menu Soft Key #5: Enables the selection of the output channel (or output groupings) using the rotary encoder dial. Menu Soft Key #1: Enables users to select from a list of Bose speaker series, or none, using the rotary encoder. Once the desired series is highlighted, press the rotary encoder to select. Menu Soft Key #3: Enables users to select from within the list of speaker families. Once the desired speaker is highlighted, press the rotary encoder to select.
Options	Series: NONE, FreeSpace®, LT, Panaray®, RoomMatch®, Custom. Model: Flat, Corresponding Bose loudspeakers, Custom user EQ curves.

MAIN MENU < DSP < ARRAY EQ	
<div style="border: 1px solid black; padding: 5px; width: fit-content;"> <p>DSP</p> <p>Speaker Presets Array EQ Delay Limiting</p> </div>	
Description	This display allows you to apply additional EQ to each input channel that feeds signal to RoomMatch® loudspeakers in array configurations.
Available Controls	<p>To access <i>Array EQ</i>, use the rotary encoder dial from the DSP menu to highlight, then press to select.</p> <p>Navigation Soft Key: Back to DSP menu.</p> <p>Menu Soft Key #5: Enables the selection of the input channel (or output groupings) using the rotary encoder dial.</p> <p>Menu Soft Key #1: Enables the selection of RoomMatch modules within the array. Use the rotary encoder to adjust this parameter.</p> <p>Menu Soft Key #2: Enables the total vertical angle of the array, in degrees, to be set. Use the rotary encoder to adjust this parameter.</p> <p>Menu Soft Key #3: Enables Array EQ to be turned ON or OFF. Use the rotary encoder to toggle the desired state.</p>
Options	<p>Modules: 2, 3, 4, 5, 6, 7, 8</p> <p>V Angle: 20 to 100 degrees in 5-degree increments</p> <p>Array EQ ON, Array EQ OFF</p>

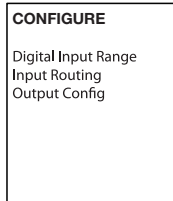
MAIN MENU < DSP < DELAY	
<div style="border: 1px solid black; padding: 5px; width: fit-content;"> <p>DSP</p> <p>Speaker Presets Array EQ Delay Limiting</p> </div>	
Description	This display allows delay to be applied to each loudspeaker output.
Available Controls	<p>To access <i>Delay</i>, use the rotary encoder dial from the DSP menu to highlight and press to select.</p> <p>Navigation Soft Key: Back to DSP menu.</p> <p>Menu Soft Key #5: Enables the selection of the output channel (or output groupings) using the rotary encoder dial.</p> <p>Menu Soft Key #1: Enables the selection of delay values, which are listed in meters, feet, milliseconds, and microseconds. Each press of this key changes the highlighted unit/quantity. Secondly, changing units allows for increased control of the delay range step size - when METERS is highlighted, coarse control is possible while uSEC affords fine control. Use the rotary encoder to adjust the selected parameter.</p> <p>Menu Soft Key #4: Enables delay to be turned ON or OFF. Use the rotary encoder to toggle the desired state.</p>
Options	<p>Delay time from 0 to 3000 milliseconds per output channel, increments dependant on selected delay unit/quantity</p> <p>Delay ON, Delay OFF</p>

MAIN MENU < DSP < LIMITING	
	
Description	This display allows you to adjust limiting parameters that allow for loudspeaker driver protection for each output channel.
Available Controls	<p>To access <i>Limiting</i>, use the rotary encoder dial from the DSP menu to highlight, then press to select.</p> <p>Navigation Soft Key: Back to DSP menu.</p> <p>Menu Soft Key #5: Enables the selection of the output channel (or output groupings) using the rotary encoder dial.</p> <p>Menu Soft Key #1: Enables the selection of a peak voltage value, which corresponds to the maximum voltage that may be applied to the driver without causing over-excursion. Use the rotary encoder to adjust the selected parameter.</p> <p>Menu Soft Key #2: Enables the selection of an RMS voltage threshold value, which works in conjunction with the subsequent attack and release values. The RMS voltage setting corresponds to the long-term power handling capability of the loudspeaker. Use the rotary encoder to adjust the selected parameter.</p> <p>Menu Soft Key #3: Enables the selection of attack time, in milliseconds, related to the RMS limiter. Use the rotary encoder to adjust the selected parameter.</p> <p>Menu Soft Key #4: Enables the selection of release time, in milliseconds, related to the RMS limiter. Use the rotary encoder to adjust the selected parameter.</p>
Options	<p>PEAK: 0.5 to 200 Volts (dependant on output mode), 0.5 V increments</p> <p>RMS: 0.5 to 100 Volts (dependant on output mode), 0.5 V increments</p> <p>ATTACK: From 500 to 10,000 milliseconds</p> <p>RELEASE: From 500 to 10,000 milliseconds</p>
Notes	<p>Values are automatically applied for Bose® loudspeakers set in MAIN MENU < DSP < SPEAKER PRESETS.</p> <p>For non-Bose loudspeakers, refer to manufacturer technical specifications for information to properly configure the limiter.</p> <p>See “Setting the Limiting Function for use with 3rd Party Loudspeakers” on page 33 for further details.</p>

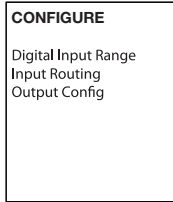
MAIN MENU < CONFIGURE	
	
Description	The CONFIGURE menu allows you to access the configuration of input and output signals for a particular system design.
Available Controls	<p>Navigation Soft Key: Return back to MAIN MENU.</p> <p>Menu Soft Key #1-5: Changes menu to respective category.</p> <p>Rotary Encoder: Scrolls and selects menu options.</p>
Options	<p>Output Config</p> <p>Input Routing</p>

MAIN MENU < CONFIGURE < DIGITAL INPUT RANGE	
	
Description	On 4-channel models (PM4500, PM4250), a group of channels from expansion cards card can be mapped to input channels A-D.
Available Controls	<p>"To access Digital Input Range, use the rotary encoder dial from the CONFIGURE menu to highlight, then press to select.</p> <p>Navigation Soft Key: Back to CONFIG menu.</p> <p>Menu Soft Key #1 and 2: Selects a range of digital input channels for access by the amplifier."</p>
Options	[1-4], [5-8]
Notes	Amplifier models PM4500 and PM4250 are input channel limited to four analog and/or four digital channels. For additional flexibility, 8-channel feeds from the digital expansion slot have been grouped into 4-channel banks for selective use in installations with multiple 4-channel PowerMatch® amplifiers.

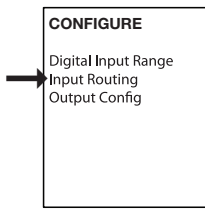
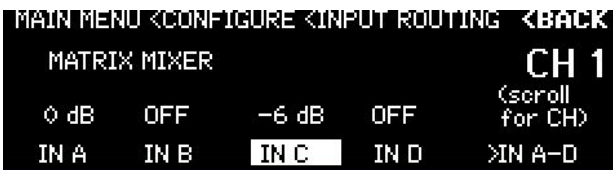
MAIN MENU < CONFIGURE < INPUT ROUTING	
	
Description	This display allows you to assign a mix of input signals to each of the output channels.
Available Controls	<p>To access <i>Input Routing</i>, use the rotary encoder dial from the <i>CONFIGURE</i> menu to highlight, then press to select.</p> <p>Navigation Soft Key: Back to CONFIG menu.</p> <p>Rotary Encoder: Scrolls through output channels.</p> <p>Menu Soft Key #5: Enables the selection of two input channels pages. Use the rotary encoder dial to toggle between input channel groupings A-D or E-H (8-channel models).</p> <p>Menu Soft Key #1-4: Enables the selection of one of the displayed input channels. A second press of the soft key will toggle between states "OFF" and a user-adjustable gain value. Once an input channel is highlighted and showing a gain value, use the rotary encoder wheel to dial the desired amount of signal to be applied to the displayed channel.</p>
	OFF, -60dB to 0dB in 1dB increments
Notes	Bose suggests that you first configure output modes (MAIN MENU < CONFIG < OUTPUT CONFIG) before performing input routing.

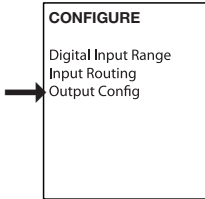
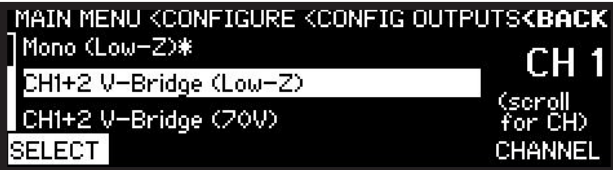
MAIN MENU < CONFIGURE < OUTPUT CONFIG			
			
Description	This display allows you to configure the output section of the amplifier for various output modes.		
Available Controls	<p>To access <i>Output Configuration</i>, use the rotary encoder dial from the <i>CONFIGURE</i> menu to highlight, then press to select.</p> <p>Note: The amplifier must be off-line from ControlSpace® Designer™ software before making any output configuration changes.</p> <p>Navigation Soft Key: Back to CONFIG menu.</p> <p>Menu Soft Key #5: Enables the selection of the output channel (or output groupings) using the rotary encoder dial.</p> <p>Menu Soft Key #1: Enables the selection of an output configuration for the displayed output channel. Use the rotary encoder to adjust the selected parameter. Once the desired mode is highlighted, press the rotary encoder to select.</p>		
Options	<table border="0" style="width: 100%;"> <tr> <td style="width: 50%; vertical-align: top;"> <p><i>For Channels 1 and 2</i></p> <p>Mono (Low-Z) Ch1+2 V-Bridge (Low-Z) Ch1+2 V-Bridge (70V) Ch1+2 V-Bridge (100V) Ch1+2 I-Share (Low-Z) Ch1+2+3+4 Quad (Low-Z) Ch1+2+3+4 Quad (70 V) Ch1+2+3+4 Quad (100 V)</p> <p><i>For Channels 5 and 6 (8-channel models only)</i></p> <p>MONO Ch5+6 V-Bridge (Low-Z) Ch5+6 V-Bridge (70V) Ch5+6 V-Bridge (100V) Ch5+6 I-Share (Low-Z) Ch5+6+7+8 Quad (Low-Z) Ch5+6+7+8 Quad (70 V) Ch5+6+7+8 Quad (100 V)</p> </td> <td style="width: 50%; vertical-align: top;"> <p><i>For Channels 3 and 4</i></p> <p>Mono (Low-Z) Ch3+4 V-Bridge (Low-Z) Ch3+4 V-Bridge (70V) Ch3+4 V-Bridge (100V) Ch3+4 I-Share (Low-Z) Ch1+2+3+4 Quad (Low-Z) Ch1+2+3+4 Quad (70 V) Ch1+2+3+4 Quad (100 V)</p> <p><i>For Channels 7 and 8 (8-channel models only)</i></p> <p>MONO Ch7+8 V-Bridge (Low-Z) Ch7+8 V-Bridge (70V) Ch7+8 V-Bridge (100V) Ch7+8 I-Share (Low-Z) Ch5+6+7+8 Quad (Low-Z) Ch5+6+7+8 Quad (70 V) Ch5+6+7+8 Quad (100 V)</p> </td> </tr> </table>	<p><i>For Channels 1 and 2</i></p> <p>Mono (Low-Z) Ch1+2 V-Bridge (Low-Z) Ch1+2 V-Bridge (70V) Ch1+2 V-Bridge (100V) Ch1+2 I-Share (Low-Z) Ch1+2+3+4 Quad (Low-Z) Ch1+2+3+4 Quad (70 V) Ch1+2+3+4 Quad (100 V)</p> <p><i>For Channels 5 and 6 (8-channel models only)</i></p> <p>MONO Ch5+6 V-Bridge (Low-Z) Ch5+6 V-Bridge (70V) Ch5+6 V-Bridge (100V) Ch5+6 I-Share (Low-Z) Ch5+6+7+8 Quad (Low-Z) Ch5+6+7+8 Quad (70 V) Ch5+6+7+8 Quad (100 V)</p>	<p><i>For Channels 3 and 4</i></p> <p>Mono (Low-Z) Ch3+4 V-Bridge (Low-Z) Ch3+4 V-Bridge (70V) Ch3+4 V-Bridge (100V) Ch3+4 I-Share (Low-Z) Ch1+2+3+4 Quad (Low-Z) Ch1+2+3+4 Quad (70 V) Ch1+2+3+4 Quad (100 V)</p> <p><i>For Channels 7 and 8 (8-channel models only)</i></p> <p>MONO Ch7+8 V-Bridge (Low-Z) Ch7+8 V-Bridge (70V) Ch7+8 V-Bridge (100V) Ch7+8 I-Share (Low-Z) Ch5+6+7+8 Quad (Low-Z) Ch5+6+7+8 Quad (70 V) Ch5+6+7+8 Quad (100 V)</p>
<p><i>For Channels 1 and 2</i></p> <p>Mono (Low-Z) Ch1+2 V-Bridge (Low-Z) Ch1+2 V-Bridge (70V) Ch1+2 V-Bridge (100V) Ch1+2 I-Share (Low-Z) Ch1+2+3+4 Quad (Low-Z) Ch1+2+3+4 Quad (70 V) Ch1+2+3+4 Quad (100 V)</p> <p><i>For Channels 5 and 6 (8-channel models only)</i></p> <p>MONO Ch5+6 V-Bridge (Low-Z) Ch5+6 V-Bridge (70V) Ch5+6 V-Bridge (100V) Ch5+6 I-Share (Low-Z) Ch5+6+7+8 Quad (Low-Z) Ch5+6+7+8 Quad (70 V) Ch5+6+7+8 Quad (100 V)</p>	<p><i>For Channels 3 and 4</i></p> <p>Mono (Low-Z) Ch3+4 V-Bridge (Low-Z) Ch3+4 V-Bridge (70V) Ch3+4 V-Bridge (100V) Ch3+4 I-Share (Low-Z) Ch1+2+3+4 Quad (Low-Z) Ch1+2+3+4 Quad (70 V) Ch1+2+3+4 Quad (100 V)</p> <p><i>For Channels 7 and 8 (8-channel models only)</i></p> <p>MONO Ch7+8 V-Bridge (Low-Z) Ch7+8 V-Bridge (70V) Ch7+8 V-Bridge (100V) Ch7+8 I-Share (Low-Z) Ch5+6+7+8 Quad (Low-Z) Ch5+6+7+8 Quad (70 V) Ch5+6+7+8 Quad (100 V)</p>		
Notes	Selection of channels will display modes that offer possible combined channels available only to those respective channels.		

MAIN MENU < UTILITY	
<p>→ UTILITY</p> <ul style="list-style-type: none"> Standby mode Alarm Log Network Setup (Device ID) Lock Front Panel Set Front Panel Lock Combination Display Restore Factory Settings Firmware Version 	
Description	The UTILITY menu allows you to access additional configuration parameters of the amplifier.
Available Controls	Navigation Soft Key: Return back to MAIN MENU. Menu Soft Key #1-5: Changes menu to respective category. Rotary Encoder: Scrolls and selects menu options.
Options	Standby Mode Alarm Log Network Setup (network versions) / Device ID (USB-only versions) Lock Front Panel Set Front Panel Lock Combination Display Restore Factory Settings Firmware Version
Notes	Further utility and monitoring options are available using ControlSpace® Designer™ software. See "Interface Comparison Table" on page 30 for the complete list of available functionality.

MAIN MENU < UTILITY < STANDBY	
<p>→ UTILITY</p> <ul style="list-style-type: none"> Standby mode Alarm Log Network Setup (Device ID) Lock Front Panel Set Front Panel Lock Combination Display Restore Factory Settings Firmware Version 	
Description	This display allows you to safely disable all amplifier output channels. This feature is helpful when changing speaker output connections while maintaining amplifier power on.
Available Controls	To access the Standby Mode, use the rotary encoder dial from the UTILITY menu to highlight, then press to select. Navigation Soft Key: Back to UTILITY menu. Rotary Encoder: Scrolls through output channels. Menu Soft Key #1: Enables amplifier output channels (exit Standby Mode). Menu Soft Key #5: Disables amplifier output channels (enter Standby Mode).
Options	Exit Standby, Enter Standby
Notes	The messaging on the screen will display the current state of this mode: "Not in Standby" or "In Standby."

MAIN MENU < UTILITY < ALARM LOG	
<div style="border: 1px solid black; padding: 5px;"> <p>UTILITY</p> <ul style="list-style-type: none"> Standby mode Alarm Log → Network Setup (Device ID) Lock Front Panel Set Front Panel Lock Combination Display Restore Factory Settings Firmware Version </div>	
Description	This display allows you to view, clear, and erase the last 50 captured alarm notifications.
Available Controls	<p>To access ALARM LOG, use the rotary encoder dial from the UTILITY menu to highlight, then press to select.</p> <p>Navigation Soft Key: Back to UTILITY menu.</p> <p>Menu Soft Key #5: Enables the rotary encoder dial to scroll through the alarm log.</p> <p>Menu Soft Key #1: Clears the alarm indicated by the FAULT LED on the front panel.</p> <p>Menu Soft Key #3: Erases all entries captured in the alarm log. A confirmation screen is presented by which users can confirm (Soft Key #1) or cancel (Soft Key #5).</p>
Options	Clear Alarm, Erase Log, Scroll.
Notes	ControlSpace® Designer™ software allows you to configure and view additional information about alarm and fault conditions.

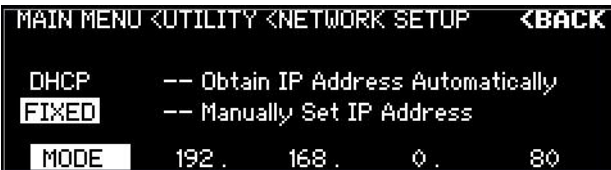
MAIN MENU < UTILITY < NETWORK SETUP (network versions)	
<div style="border: 1px solid black; padding: 5px;"> <p>UTILITY</p> <ul style="list-style-type: none"> Standby mode Alarm Log → Network Setup (Device ID) Lock Front Panel Set Front Panel Lock Combination Display Restore Factory Settings Firmware Version </div>	
Description	This display allows you to set the network IP address of the amplifier.
Available Controls	<p>To access Network Setup, use the rotary encoder dial from the UTILITY menu to highlight, then press to select.</p> <p>Navigation Soft Key: Back to UTILITY menu.</p> <p>Menu Soft Key #1: Enables the rotary encoder dial to toggle between DHCP or FIXED IP address mode. Push the rotary encoder to enable the selection. A confirmation screen is presented by which users can confirm (Soft Key #1) or cancel (Soft Key #5). Upon confirmation, the unit will save and reboot using the new setting.</p> <p>Menu Soft Key #2-5: Enables the rotary encoder dial to adjust the value of each IP address octet. Once the IP address has been fully modified, push the rotary encoder to enable the selection. A confirmation screen is presented by which users can confirm (Soft Key #1) or cancel (Soft Key #5). Upon confirmation, the unit will save and reboot using the new setting.</p>
Options	<p>Mode: DHCP, Fixed</p> <p>IP Address Octet Values: 0 to 255</p>
Notes	DHCP is enabled by default on network version amplifiers. Upon Power Up, resolving of DHCP times out after 10 seconds to IP:80 for PM8500N/PM8250N and IP:40 for PM4500N/PM4250N.

MAIN MENU < UTILITY < DEVICE ID (USB-only versions)	
<div style="border: 1px solid black; padding: 5px;"> <p>UTILITY</p> <ul style="list-style-type: none"> Standby mode Alarm Log → Network Setup (Device ID) Lock Front Panel Set Front Panel Lock Combination Display Restore Factory Settings Firmware Version </div>	
Description	This display allows you to set the device identification number of the amplifier.
Available Controls	<p>To access Device ID Setup, use the rotary encoder dial from the UTILITY menu to highlight, then press to select.</p> <p>Navigation Soft Key: Back to UTILITY menu.</p> <p>Rotary Encoder: Use the dial to scroll through device ID values. Push the rotary encoder to set the new device ID. A confirmation screen is presented by which users can confirm (Soft Key #1) or cancel (Soft Key #5).</p>
Options	Device ID Number: 1-255

MAIN MENU < UTILITY < LOCK FRONT PANEL

<div style="border: 1px solid black; padding: 5px;"> <p>UTILITY</p> <p>Standby mode Alarm Log Network Setup (Device ID) Lock Front Panel Set Front Panel Lock Combination Display Restore Factory Settings Firmware Version</p> </div> <p>→</p>	
<p>Description</p>	<p>This display allows you to view the current unlock combination and ability to lock the front panel controls to prevent tampering.</p>
<p>Available Controls</p>	<p>To access Lock Front Panel, use the rotary encoder dial from the UTILITY menu to highlight, then press to select.</p> <p>Navigation Soft Key: Back to UTILITY menu.</p> <p>Rotary Encoder: Press the rotary encoder to set the front panel lock.</p>
<p>Options</p>	<p>Lock now</p>
<p>Notes</p>	<p>Once locked, users accessing the rotary encoder or any of the soft keys are prompted with an unlock screen by which the combination previously shown in MAIN MENU < UTILITY < LOCK FRONT PANEL must be entered to regain access to the Main Menu.</p> <p>Users that have misplaced a combination and are locked out can use ControlSpace® Designer™ software to connect, unlock the front panel, and view a previously assigned lock combination.</p>

MAIN MENU < UTILITY < LOCK COMBINATION

<div style="border: 1px solid black; padding: 5px;"> <p>UTILITY</p> <p>Standby mode Alarm Log Network Setup (Device ID) Lock Front Panel Set Front Panel Lock Combination Display Restore Factory Settings Firmware Version</p> </div> <p>→</p>	
<p>Description</p>	<p>This display allows you to set the front panel lock combination.</p>
<p>Available Controls</p>	<p>To access Set Front Panel Combination, use the rotary encoder dial from the UTILITY menu to highlight, then press to select.</p> <p>Navigation Soft Key: Back to UTILITY menu.</p> <p>Menu Soft Key #1-5: Enables each of the five digits to be selected and modified by using the rotary encoder dial.</p>
<p>Options</p>	<p>0-9 for digits 1-5.</p>

MAIN MENU < UTILITY < DISPLAY

<div style="border: 1px solid black; padding: 5px;"> <p>UTILITY</p> <p>Standby mode Alarm Log Network Setup (Device ID) Lock Front Panel Set Front Panel Lock Combination Display Restore Factory Settings Firmware Version</p> </div> <p>→</p>	
<p>Description</p>	<p>This display allows you to set the display intensity.</p>
<p>Available Controls</p>	<p>To access the Display menu, use the rotary encoder dial from the UTILITY menu to highlight, then press to select.</p> <p>Navigation Soft Key: Back to UTILITY menu.</p> <p>Menu Soft Key #1: Sets the display backlight intensity to "Normal" or bright.</p> <p>Menu Soft Key #2: Sets the display backlight intensity to "Dim" or low.</p>
<p>Options</p>	<p>Normal, Dim</p>

MAIN MENU < UTILITY < RESTORE FACTORY

<div style="border: 1px solid black; padding: 5px;"> <p>UTILITY</p> <p>Standby mode Alarm Log Network Setup (Device ID) Lock Front Panel Set Front Panel Lock Combination Display → Restore Factory Settings Firmware Version</p> </div>	
<p>Description</p>	<p>This display allows you to erase all settings and return the amplifier options to the state set by the factory.</p>
<p>Available Controls</p>	<p>To access the Restore Factory Settings menu, use the rotary encoder dial from the UTILITY menu to highlight, then press to select.</p> <p>Navigation Soft Key: Back to UTILITY menu.</p> <p>Menu Soft Key #1: Begins the process to restore the amplifier settings to factory condition. A confirmation screen is presented by which users can confirm (Soft Key #1) or cancel (Soft Key #5).</p>
<p>Options</p>	<p>Restore</p>
<p>Notes</p>	<p>Invoking <i>Restore Factory Settings</i> will change the "power on state" of the amplifier such that all front panel setting changes will be saved and recalled on each subsequent power up. This state can be modified using ControlSpace® Designer™ software.</p>

MAIN MENU < UTILITY < FIRMWARE VERSION

<div style="border: 1px solid black; padding: 5px;"> <p>UTILITY</p> <p>Standby mode Alarm Log Network Setup (Device ID) Lock Front Panel Set Front Panel Lock Combination Display → Restore Factory Settings Firmware Version</p> </div>	
<p>Description</p>	<p>This display allows you to view the model number, hardware software versions, installed Bose® loudspeaker EQ presets file, and status of any plug-in cards.</p>
<p>Available Controls</p>	<p>To access the Firmware Versions menu, use the rotary encoder dial from the UTILITY menu to highlight, then press to select.</p> <p>Navigation Soft Key: Back to UTILITY menu.</p>

Setting the Limiting Function for use with 3rd Party Loudspeakers

The Limiting function allows you to restrict, per channel, the maximum signal level to the loudspeaker. Here are some simplified steps to aid in setting the limiter function.

1. Locate the technical data specification sheet for the 3rd party loudspeaker.
2. Configure the amplifier outputs (**MAIN MENU < CONFIG < OUTPUT CONFIG**) to drive the loudspeaker at or beyond the rated power of the loudspeaker indicated in the loudspeaker’s data specification sheet.
3. Select the proper EQ (flat or custom EQ for non-Bose loudspeakers) from **MAIN MENU < DSP < SPEAKER PRESETS**.
4. Using the manufacturer’s loudspeaker specification sheet, calculate the limiter RMS voltage using the loudspeaker’s continuous power rating using the following formula:

$$\text{RMS Voltage} = \text{Square Root} (\text{rated power of the loudspeaker} \times \text{loudspeaker impedance}).$$
5. In the **MAIN MENU < DSP < LIMITING** menu, select the appropriate output channel and set the **RMS** voltage to the loudspeaker’s RMS voltage.
6. Set the **Peak** value to 1.4 to 2 times the RMS voltage. Note the maximum RMS and Peak voltage values below in Figure 11 when setting these parameters.
7. Reference loudspeaker data specifications or consult with loudspeaker manufacturer to obtain optimal settings for Attack and Release parameters.

Figure 11. Output Channel Limiter Maximum Voltage Values

Mode	Peak	RMS V
Mono	71 V	50 V
I-Share	71 V	50 V
V-Bridge	142 V	100 V
Quad	142 V	100 V

Sample Output Configurations for Different Loudspeaker Loads

For reference, the following two examples illustrate two different output configurations using RoomMatch® array module loudspeakers with PM8500 or PM4500 amplifiers. Front panel configuration settings are provided. While not covered in this documentation, ControlSpace® Designer™ software provides additional configurability to these examples. Further information on this software can be found on pro.Bose.com.

Configuration of a RoomMatch® Two-Module Array (Example 1)

In this example, two full-range RoomMatch array modules are connected to one PowerMatch® amplifier, arranged as follows:

(2) Bose® RoomMatch 7010 array module loudspeakers (70° H x 10° V)

(1) Bose PowerMatch PM4500 configurable professional power amplifier (PM8500 amplifier similar)

Figure 12. RoomMatch two-module array configuration

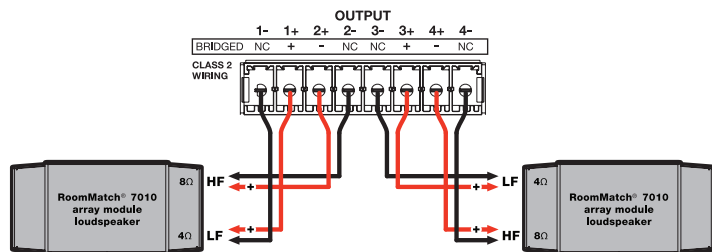

Note: All RoomMatch loudspeaker connections use Neutrik® NL4 speakON-type cable connectors. Please refer to RoomMatch loudspeaker documentation for further details.

Front Panel Configuration Menu Settings:

1. **MAIN MENU < CONFIG < OUTPUT CONFIG**

Set the output configuration for channels 1-4 to MONO mode.

2. **MAIN MENU < DSP < SPEAKER PRESETS**

For channels 1 and 3 set SERIES to “RoomMatch” and MODEL to “RM_Array LF.”

For channels 2 and 4 set SERIES to “RoomMatch” and MODEL to “RM_Array HF.”

3. **MAIN MENU < DSP < ARRAY EQ**

For each input channel that is routed to an output channel, set the MODULES value to 2 and the V-Angle parameter to 20 degrees, which is the total vertical angle of the shown modules. Ensure that the state of the Array EQ is set to ON.

Configuration of a RoomMatch RMS215 Subwoofer Module (Example 2)

In this example, one subwoofer module is connected to one PowerMatch amplifier, arranged as follows:

(1) Bose RoomMatch RMS215 subwoofer

(1) Bose PowerMatch PM8500 configurable professional power amplifier

Figure 13. RoomMatch subwoofer configuration

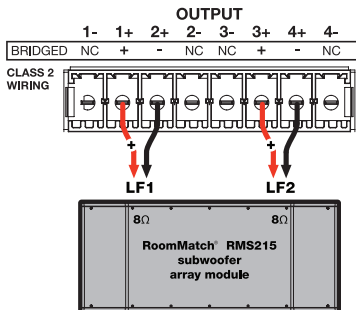

Front Panel Configuration Menu Settings:

1. **MAIN MENU < CONFIG < Output Config**

Set the output configuration for channels 1+2 and 3+4 to V-Bridge (Low-Z) mode.

2. **MAIN MENU < DSP < Speaker Presets**

For channels 1+2 and 3+4, set SERIES to “RoomMatch” and MODEL to “RMS215.”

Maintenance Operations

Updating Firmware and Speaker EQ Presets

Each PowerMatch® amplifier contains two user-updatable files: Firmware and loudspeaker EQ files. These files can both be updated from ControlSpace® Designer™ software using a PC connected to either the USB connection on the front panel of the amplifier, or, in the case of a network version amplifier, an Ethernet network connection (use shielded CAT5e cable only).

The firmware version of the amplifier can be viewed directly on the front panel by selecting **MAIN MENU < UTILITY < FIRMWARE VERSIONS**. The version of both firmware and EQ files can be viewed in ControlSpace Designer software.

Please refer to the ControlSpace Designer software user’s guide available on **pro.Bose.com** for software installation instructions.

From within ControlSpace Designer software, firmware and EQ file information can be found in the Hardware Manager. To launch this feature, click **Hardware Manager** in the System Menu or click the **Hardware Manger** button in amplifier properties window.

Figure 14. Launching the Hardware Manager

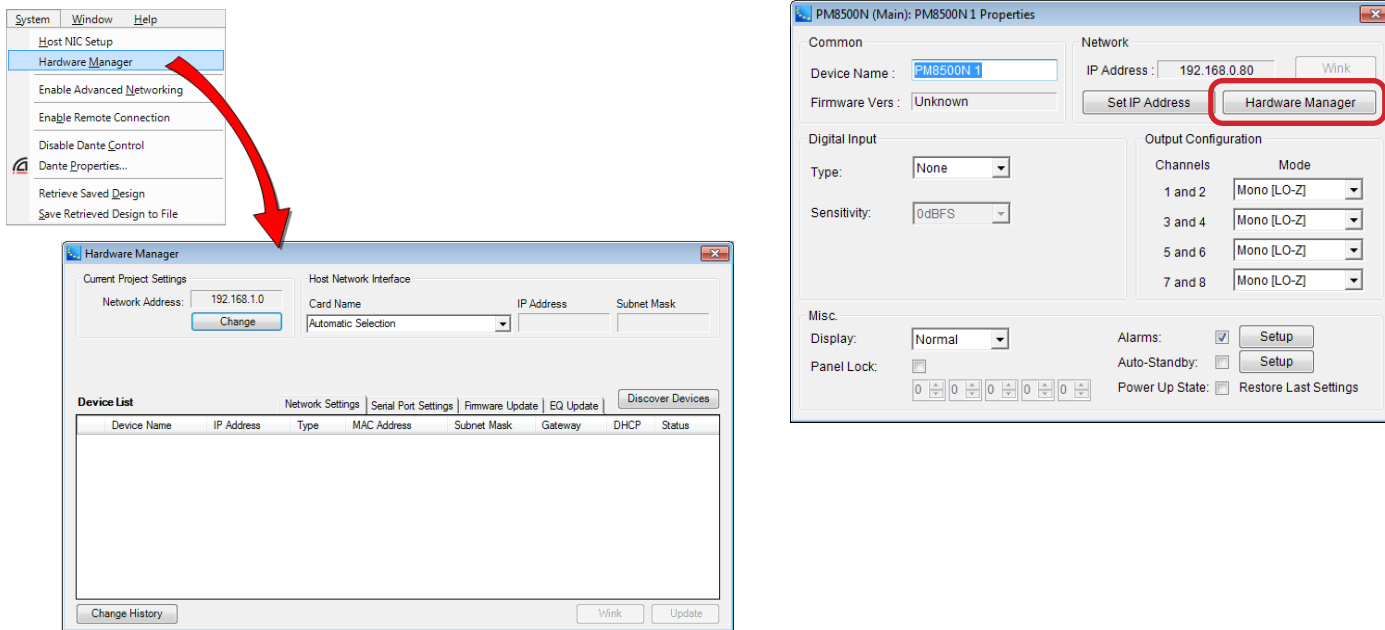

Upon launching the Hardware Manager, the software performs a scan to determine the devices on the network and adds them to the Device List. Select the **Firmware Update** tab (Figure 15) to view the firmware file status, and select the **EQ Update** tab (Figure 16) to view EQ file status. If a file is out-of-date, select the device and click the **Update** button.

Figure 15. Firmware Update window

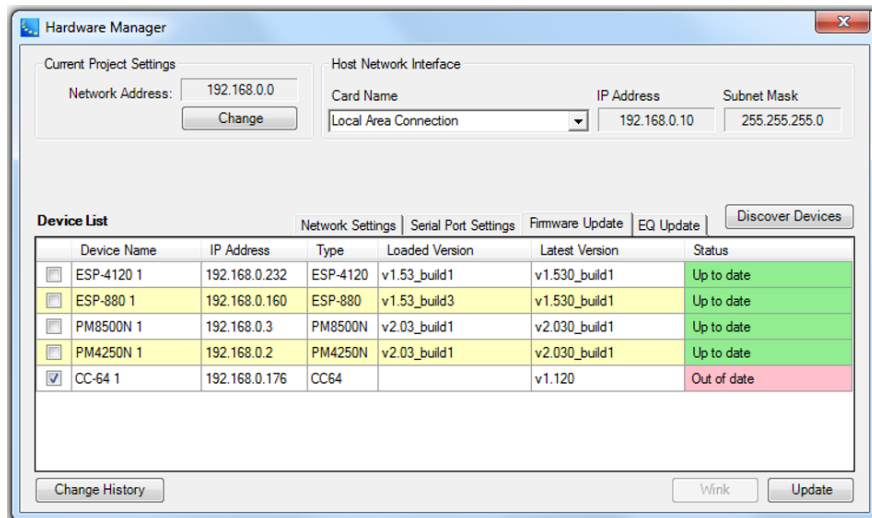
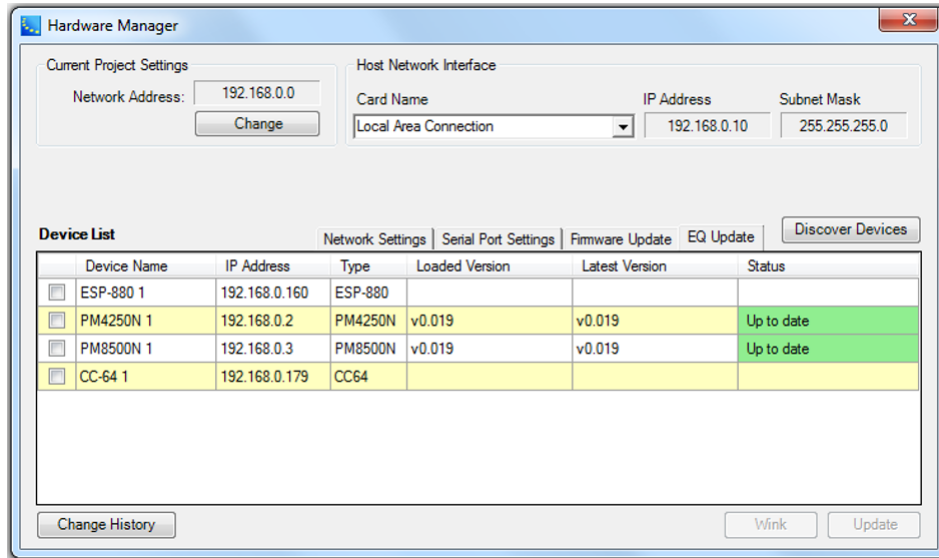

Figure 16. EQ Update window



Note: Between timed releases of ControlSpace® Designer™ software, PowerMatch® firmware updates and loudspeaker EQ files may become available. Check pro.Bose.com for updates and instructions on how to load and apply these files.

Saving and Recalling Amplifier Settings (USB-only version amplifiers)

You can save amplifier settings using a PC, USB connection, and ControlSpace Designer software. This may be useful for archiving settings made on the front panel after installation. You may also find it useful to copy settings from one PowerMatch amplifier to other PowerMatch amplifiers.

To save front panel settings:

1. Install ControlSpace Designer software on a compatible PC.
2. Connect the PC to the amplifier using USB.
3. Start ControlSpace Designer.
4. The amplifier should automatically connect and populate into the Project Window.
5. Save the Project File by selecting **File -> Save As...** from the menu bar.

To replace front panel settings with a previously saved file:

1. Start ControlSpace Designer.
2. Open the previously saved Project File by selecting **File -> Open** from the menu bar.
3. Connect the PC to the amplifier using USB.
4. Click the YES button when presented with a dialog box asking, “Go Online via USB?”
5. Click “Send to Device” in the Settings Transfer window (Figure 17) to push the settings to the connected amplifier.

Figure 17. Settings Transfer window

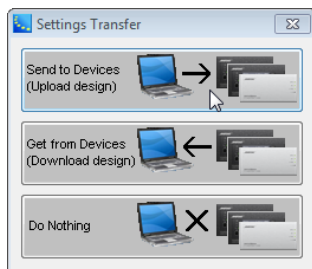

Saving and Recalling Amplifier Settings (network version amplifiers)

With any network version amplifier, you can save and update device settings within a networked system with one or more amplifiers. This process is outside the scope of this guide. Refer to the ControlSpace Designer software documentation for details.

About the Alarm Log and Fault Indicator

The PowerMatch® amplifier monitors operating temperature, power supply status, amplifier status, open and short wiring, and additional conditions for issues.

When issues are detected, the last 50 issues are stored in the amplifier in an internal log found by accessing **MAIN MENU < UTILITY < ALARM LOG** from the front panel.

Information from the alarm log can also be viewed using ControlSpace® Designer™ software. In systems where ControlSpace Designer software is actively connected, either via USB or Ethernet, the time and date of the alarm condition is appended to the alarm log entry on the PC. Locally stored alarm information has no time/date information, but is shown in order of last occurrence.

Critical internal system-related issues are always considered faults and will trigger the fault-notification output and the Fault LED on the front panel. However, you have the ability to select whether certain conditions are faults using ControlSpace Designer software. Refer to the ControlSpace Designer software documentation for details on how to view and manage alarms.

The table below lists the possible fault conditions and recommendations on how to address these conditions. Variables are shown as "x", "X", or "y", but will be displayed as values or part numbers in the actual alarm text string.

Figure 18. Fault Conditions

Customer Serviceable Warnings and Alarms	
Fault Text	Suggestions for Resolution
Internal protection applied on Channel x	Amplifier approaching operating/thermal limit on channel x, gain reduced, self-clearing fault. Optional alarm condition in ControlSpace Designer.
Limiting applied on Channel x	Limiting was applied on output x, self-clearing when signal level lowers.
Open detected on Channel x	Check loudspeaker and cabling for open circuit on output x.
Clipping on Channel x	Reduce input signal channel x.
AC loss detected/AC returned	Installation activity noticed. Clear error and check again. If continued error, check for AC mains voltage sag or change to new circuit.
Digital Audio Input loss detected	No issue, self-clearing. Check digital audio input connections.
large parallel Vdiff on ch x	Shorting jumpers not installed properly.
short on ch x	Check loudspeaker and cabling for short circuit on output x. Cycle Power.
ext digital clk out of range, using internal clk	Reinsert accessory card, reboot amplifier. Replace card if error continues.
no proc table loaded	Software error, restore factory defaults.
Power supply temperature above max allowed	Amplifier signal should be reduced, check ambient temp of rack.
Amp x temperature above max allowed	Amplifier signal should be reduced, check ambient temp of rack.
pwr supply temp above max	Amplifier signal should be reduced, check ambient temp of rack.
amp x temp above max	Amplifier signal should be reduced, check ambient temp of rack.
fuse saver indicates circuit breaker near limit	Amplifier signal should be reduced, check ambient temp of rack. Check mains for low voltage.
FET temp above max	Amplifier signal should be reduced, check ambient temp of rack.
too much I ² t on ch x	Amplifier signal should be reduced, check ambient temp of rack.
pwr supply rail below min	Check mains supply for low line voltage. Change circuit.
EHF detected on ch x	Check loudspeaker and cabling for short circuit on output x. Cycle Power.

Non-Customer Serviceable Warnings and Alarms	
Fault Text	Resolution
Both amp or PS fan fail	Requires Bose® Support. Call Bose Representative.
Power supply fault ICV not OK	
power supply fault DC not OK	
power supply fault DC_200 not OK	
power supply fault AC_line not detected	
Flash memory fault	
DSP boot failure	
System Halted	
audio disabled: DSP I2C error on VI meas ADC ch x	
audio disabled: DSP I2C error on DAC ch x	
audio disabled: DSP I2C error on EHF for amp x	
no ADC input	

Non-Customer Serviceable Warnings and Alarms

Fault Text	Resolution
DSP processing resources exceeded	Requires Bose® Support. Call Bose Representative.
ADC XXXXXX on input board I2C err	
ADC XXXXXX on digital board I2C err	
ADC XXXXXX amp x I2C err	
DAC XXXXXX amp x (x&x) I2C err	
XXXXXXX(EHF) amp x I2C err	
XXXXXXX(temp) amp x I2C err	
XXXXXXX(PS) I2C err	

Troubleshooting

Problem	Possible Solution
No power	<ul style="list-style-type: none"> • Turn on power switch. Clip, Limit, and Signal LEDs should stay lit for approximately the first 15 seconds, after which the amplifier should be fully ready for operation. The amplifier's LCD screen will show the firmware version screen after about 10 seconds, then revert to the operating screen. • Check power cable, ensure retaining clip is in place. • Check mains circuit.
Power is on, but no sound	<p>Check the LCD screen for output meter activity. If no signal activity, check the following:</p> <ul style="list-style-type: none"> • Check the Input Meter screen for presence of signal. If no signal, fix source or cabling. • Ensure that input and output signals are not muted. • Check that Input Routing is configured properly. • Check that Input Source is set to appropriate signal type (analog or digital). • Check that Output Attenuate is not set too low. • Make sure loudspeakers are wired correctly to output connectors. • Check that Output Configuration is set correctly. • Check that Standby Mode is not active.
Power is on, sound is low	<ul style="list-style-type: none"> • Verify source level by monitoring Input Meter. Check that Input Routing and Input Sensitivity are set for optimal gain. • Check that Output Attenuate is not set too low. • Make sure loudspeakers are wired correctly to output connectors. • Check that Output Configuration is set correctly. • Check that Limiting parameters are set properly.
Unnatural sound	Check that all DSP functions (EQs, Limiter, Band Pass, Delay) are set appropriately.
Front panel is locked out, combination is lost	Use ControlSpace® Designer™ software to connect to the amplifier and unlock the front panel.
Fault LED is lit	Refer to Figure 18, "Fault Conditions" on page 37 for alarm conditions and potential solutions. Call your local Bose® Support contact for assistance with unlisted or unsolvable faults.
USB is connected to PC but not found by ControlSpace Designer software	<ul style="list-style-type: none"> • Unplug/replug USB connector. • Uninstall ControlSpace Designer software, download the latest version, reinstall. • Restart PC, try again. • Try another USB port on the computer. • Try another USB cable. • Check ControlSpace Designer software documentation for more details.
Ethernet is connected to network but amplifier is not found by ControlSpace Designer software (PowerMatch network versions only)	<ul style="list-style-type: none"> • Check the IP address of the PowerMatch® amplifier. • Ensure that there is not another device with the same address on the network. • Ensure ControlSpace Designer is connected to the same subnet as the PowerMatch amplifier. • Try another shielded CAT5e cable. • Launch a Windows Command prompt window (cmd.exe) and enter the text "ping" followed by the IP address of the amplifier at the command prompt then press enter key. This should result in four successful replies from the amplifier.

Appendix

Interface Comparison Table

Function	Front Panel Interface	ControlSpace® Designer software
Set input sensitivity (dBu)	X	X
Set input gain (dB)	X	X
Set input mute	X	X
View input level (dB)	X	X
Set output attenuation (dB)	X	X
Set output mute	X	X
View output gain (dB)	X	X
View output voltage (V)	X	X
Load Bose® speaker EQ preset	X	X
View Bose speaker EQ	X	X
Load speaker array EQ	X	X
Adjust delay	X	X
Adjust limiting	X	X
Modify output configuration	X	X
Modify input routing	X	X
Enter/exit standby mode	X	X
View alarm log	X	X
Clear alarm	X	X
Erase alarm log	X	X
Set DHCP or Fixed IP network address	X	X
Lock front panel	X	X
Set front panel combination	X	X
Adjust display contrast	X	X
Restore factory presets	X	X
View firmware version	X	X
Update firmware version	X	X
Update speaker EQ files	X	X
Adjust/view input channel 5-Band PEQ		X
Adjust/view advanced parameters for Array EQ		X
Use of signal generator		X
Adjust/view Bandpass Filters		X
Adjust/view advanced parameters for Speaker EQ		X
Use of Limiter Meters		X
Use of Link Groups		X
Per channel fault and limit indicators		X
Set Auto-Standby parameters		X
Wake from Auto-Standby	X	X
Set input type (analog vs digital)	X	X
Setup of alarm conditions		X
Measure/save/compare loudspeaker impedances		X
Local Monitor Mode		X
Network Monitor Mode		X
Configure and monitor multiple amplifiers		X
Backup/restore amplifier configuration state		X

Technical Specifications - Common to all PowerMatch® models

Audio Performance Specifications	
Frequency Response	20 Hz - 20 kHz (@ 1 W and +/- 0.5 dB)
Signal-to-Noise Ratio, Analog Input	> 102 dB (PM8500 and PM4500), > 99 dB (PM8250 and PM4250), below rated power, A-weighted
THD	< 0.4 % (at 1 W, 20 Hz to 20 kHz)
Intermod Distortion - SMPTE	< 0.4 % (60 Hz, 7 kHz)
Channel Separation (Crosstalk)	> 65 dB (adjacent channels, at 1 kHz)
Damping Factor	> 1000 (10-1000 Hz, 4 ohms, at amplifier output)

Integrated DSP	
A/D and D/A Converters	48 kHz / 24-bit
Total Latency (Analog In - Amp Out)	< 0.95 ms
Input to Output Signal Routing	8 x 8 matrix (PM8500 and PM8250), 4 x 4 matrix (PM4500 and PM4250)
Loudspeaker Presets	Bose Professional
Input EQ	5-band PEQ (+/- 20 dB), notch, shelving, high pass, low pass
Bandpass Filters (Crossover)	Butterworth, Bessel, or Linkwitz-Riley, up to 48 dB/octave
Loudspeaker EQ	9-band PEQ (+/- 20 dB), shelving, high pass, low pass, 2-band RoomMatch® array EQ
Maximum Output Delay	3 s
Output Limiter	Peak and RMS voltage

Indicators and Controls	
LED Status Indicators	Signal, limit, clip, fault
User Interface Controls	Mute, input sensitivity, output attenuation, EQ on/off, preset select. 240 x 64 LCD. Additional controls available w/ ControlSpace® Designer™ software

General	
Setup and Configuration Software	ControlSpace Designer software V3.2 or greater
PC Interface Connection	USB (Network version adds Ethernet RJ45)
Fault Notification Output	NC/NO Relay Contact (1 A, 30 VDC), 3-pin Phoenix Contact® connector (orange color; part # 1976010)

(1) Measured at +24 dBu sensitivity unless otherwise specified.

Technical Specifications - PM8500 / PM8500N

Power Rating ¹	2 Ω	4 Ω	8 Ω	70 V	100 V
THD for Power Rating, Typical	< 0.1 %	< 0.1%	< 0.1%	1%	1%
Mono Mode	450 W	500 W	300 W	See footnote 3	See footnote 3
V-Bridge Mode	450 W ₂	1000 W	1000 W	800 W	1000 W
I-Share Mode	1000 W	500 W ₂	300 W ₂	Not available	Not available
Quad Mode	1000 W ₂	2000 W	1000 W ₂	1600 W	2000 W
Maximum Rated Power	4000 W (total all channels)				
Peak Output Voltage	71 / 142 V (Mono / V-Bridge, I-Share, and Quad modes)				
Voltage Gain	33 / 36 / 33 / 36 dB (Mono / V-Bridge / I-Share / Quad modes)				
Audio Inputs	Analog			Digital (Optional Card)	
Input Channels	8 (balanced line level)			8	
Input Impedance	> 100 kΩ			N/A	
Sensitivity	0, +4, +12, +24 dBu, selectable			Digital: 0, -12, -20, -24 dBFS, selectable	
Maximum Input Level	+24 dBu (at 24 dBu sensitivity setting)			N/A	
Connectors, Input	3-pin Phoenix Contact® (green color; part # 1776168)			Card Dependent	
Audio Outputs					
Output Channels	2 to 8 configurable				
Connectors, Output	8-pin Phoenix Contact connectors (part # 1778120), supports 10-24 AWG wire				
Electrical Specification					
Mains Voltage	100-240 V (50/60 Hz)				
Mains Circuit Recommendation	20A (120 V) or 16A (230 V)				
Mains Connector	IEC 60320-C20 (Inlet)				
Minimum AC Line Voltage	80 V (reduced output power)				
Maximum Inrush Current	15.4 A (230 VAC, 50 Hz)				
Maximum RMS Current Draw	15 A				
Efficiency, 1/3 Rated Power	> 75 % (pink noise input signal, typical)				
Output Stage Topology	Class-D				
Overload Protection	High temperature, DC, HF, short, voltage limiter, current limiter, inrush current, mains circuit breaker protection				
Physical					
Dimensions	3.5" H x 19" W x 20.7" D (88 mm x 483 mm x 525 mm) - EIA-310 standard width, 2RU height				
Net Weight	28.4 lb (12.9 kg)				
Shipping Weight	34.5 lb (15.7 kg)				
Mounting Depth	21" (533 mm)				
Operating Temperature	32 °F - 104 °F (0 °C - 40 °C)				
Cooling System	Microprocessor-controlled, variable-speed fans, front to rear airflow				

(1) Output power is measured per channel, all channels driven, using test signals at 1 kHz.

(2) Configuration not recommended / not optimal.

(3) Limited use available. Tap 70V loudspeakers 2x the desired power. Tap 100V loudspeakers 4x the desired power. Refer to the application note "Using MONO Mode to Drive High Impedance Loudspeaker Loads."

Technical Specifications - PM8250 / PM8250N

Power Rating ¹	2 Ω	4 Ω	8 Ω	70 V	100 V
THD for Power Rating, Typical	< 0.1 %	< 0.1%	< 0.1%	1%	1%
Mono Mode	250 W	250 W	250 W	See footnote 3	See footnote 3
V-Bridge Mode	250 W ₂	500 W	500 W	400 W	500 W
I-Share Mode	500 W	250 W ₂	150 W ₂	Not available	Not available
Quad Mode	1000 W ₂	1000 W	500 W ₂	800 W	1000 W
Maximum Rated Power	2000 W (total all channels)				
Peak Output Voltage	71 / 142 V (Mono / V-Bridge, I-Share, and Quad modes)				
Voltage Gain	30 / 33 / 30 / 33 dB (Mono / V-Bridge / I-Share / Quad modes)				
Audio Inputs	Analog			Digital (Optional Card)	
Input Channels	8 (balanced line level)			8	
Input Impedance	> 100 kΩ			N/A	
Sensitivity	0, +4, +12, +24 dBu, selectable			Digital: 0, -12, -20, -24 dBFS, selectable	
Maximum Input Level	+24 dBu (at 24 dBu sensitivity setting)			N/A	
Connectors, Input	3-pin Phoenix Contact® (green color; part # 1776168)			Card Dependent	
Audio Outputs					
Output Channels	2 to 8 configurable				
Connectors, Output	8-pin Phoenix Contact®connectors (part # 1778120), supports 10-24 AWG wire				
Electrical Specification					
Mains Voltage	100-240 V (50/60 Hz)				
Mains Circuit Recommendation	15A (120 V) or 10A (230 V)				
Mains Connector	IEC 60320-C14 (Inlet)				
Minimum AC Line Voltage	80 V (reduced output power)				
Maximum Inrush Current	15.4 A (230 VAC, 50 Hz)				
Maximum RMS Current Draw	8 A				
Efficiency, 1/3 Rated Power	> 68 % (pink noise input signal, typical)				
Output Stage Topology	Class-D				
Overload Protection	High temperature, DC, HF, short, voltage limiter, current limiter, inrush current, mains circuit breaker protection				
Physical					
Dimensions	3.5" H x 19" W x 20.7" D (88 mm x 483 mm x 525 mm) - EIA-310 standard width, 2RU height				
Net Weight	28.3 lb (12.8 kg)				
Shipping Weight	34.0 lb (15.4 kg)				
Mounting Depth	21" (533 mm)				
Operating Temperature	32 °F - 104 °F (0 °C - 40 °C)				
Cooling System	Microprocessor-controlled, variable-speed fans, front to rear airflow				

(1) Output power is measured per channel, all channels driven, using test signals at 1 kHz.

(2) Configuration not recommended / not optimal.

(3) Limited use available. Tap 70V loudspeakers 2x the desired power. Tap 100V loudspeakers 4x the desired power. Refer to the application note "Using MONO Mode to Drive High Impedance Loudspeaker Loads."

Technical Specifications - PM4500 / PM4500N

Power Rating ¹	2 Ω	4 Ω	8 Ω	70 V	100 V
THD for Power Rating, Typical	< 0.1 %	< 0.1%	< 0.1%	1%	1%
Mono Mode	450 W	500 W	300 W	See footnote 3	See footnote 3
V-Bridge Mode	450 W ₂	1000 W	1000 W	800 W	1000 W
I-Share Mode	1000 W	500 W ₂	300 W ₂	Not available	Not available
Quad Mode	1000 W ₂	2000 W	1000 W ₂	1600 W	2000 W
Maximum Rated Power	2000 W (total all channels)				
Peak Output Voltage	71 / 142 V (Mono / V-Bridge, I-Share, and Quad modes)				
Voltage Gain	33 / 36 / 33 / 36 dB (Mono / V-Bridge / I-Share / Quad modes)				
Audio Inputs	Analog			Digital (Optional Card)	
Input Channels	4 (balanced line level)			4, selectable range	
Input Impedance	> 100 kΩ			N/A	
Sensitivity	0, +4, +12, +24 dBu, selectable			Digital: 0, -12, -20, -24 dBFS, selectable	
Maximum Input Level	+24 dBu (at 24 dBu sensitivity setting)			N/A	
Connectors, Input	3-pin Phoenix Contact® (green color; part # 1776168)			Card Dependent	
Audio Outputs					
Output Channels	1 to 4 configurable				
Connectors, Output	8-pin Phoenix Contact connector (part # 1778120), supports 10-24 AWG wire				
Electrical Specification					
Mains Voltage	100-240 V (50/60 Hz)				
Mains Circuit Recommendation	15A (120 V) or 10A (230 V)				
Mains Connector	IEC 60320-C14 (Inlet)				
Minimum AC Line Voltage	80 V (reduced output power)				
Maximum Inrush Current	15.4 A (230 VAC, 50 Hz)				
Maximum RMS Current Draw	8 A				
Efficiency, 1/3 Rated Power	> 73 % (pink noise input signal, typical)				
Output Stage Topology	Class-D				
Overload Protection	High temperature, DC, HF, short, voltage limiter, current limiter, inrush current, mains circuit breaker protection				
Physical					
Dimensions	3.5" H x 19" W x 20.7" D (88 mm x 483 mm x 525 mm) - EIA-310 standard width, 2RU height				
Net Weight	24.4 lb (11.1 kg)				
Shipping Weight	30.0 lb (13.6 kg)				
Mounting Depth	21" (533 mm)				
Operating Temperature	32 °F - 104 °F (0 °C - 40 °C)				
Cooling System	Microprocessor-controlled, variable-speed fans, front to rear airflow				

(1) Output power is measured per channel, all channels driven, using test signals at 1 kHz.

(2) Configuration not recommended / not optimal.

(3) Limited use available. Tap 70V loudspeakers 2x the desired power. Tap 100V loudspeakers 4x the desired power. Refer to the application note "Using MONO Mode to Drive High Impedance Loudspeaker Loads."

Technical Specifications - PM4250 / PM4250N

Power Rating ¹	2 Ω	4 Ω	8 Ω	70 V	100 V
THD for Power Rating, Typical	< 0.1 %	< 0.1%	< 0.1%	1%	1%
Mono Mode	250 W	250 W	250 W	See footnote 3	See footnote 3
V-Bridge Mode	250 W ²	500 W	500 W	400 W	500 W
I-Share Mode	500 W	250 W ²	150 W ²	Not available	Not available
Quad Mode	1000 W ²	1000 W	500 W ²	800 W	1000 W
Maximum Rated Power	1000 W (total all channels)				
Peak Output Voltage	71 / 142 / 142 V				
Voltage Gain	30 / 33 / 30 / 33 dB (Mono / V-Bridge / I-Share / Quad modes)				
Audio Inputs	Analog			Digital (Optional Card)	
Input Channels	4 (balanced line level)			4, selectable range	
Input Impedance	> 100 kΩ			N/A	
Sensitivity	0, +4, +12, +24 dBu, selectable			Digital: 0, -12, -20, -24 dBFS, selectable	
Maximum Input Level	+24 dBu (at 24 dBu sensitivity setting)			N/A	
Connectors, Input	3-pin Phoenix Contact® (green color; part # 1776168)			Card Dependent	
Audio Outputs					
Output Channels	1 to 4 configurable				
Connectors, Output	8-pin Phoenix Contact connector (part # 1778120), supports 10-24 AWG wire				
Electrical Specification					
Mains Voltage	100-240 V (50/60 Hz)				
Mains Circuit Recommendation	15A (120 V) or 10A (230 V)				
Mains Connector	IEC 60320-C14 (Inlet)				
Minimum AC Line Voltage	80 V (reduced output power)				
Maximum Inrush Current	15.4 A (230 VAC, 50 Hz)				
Maximum RMS Current Draw	4 A				
Efficiency, 1/3 Rated Power	> 66 % (pink noise input signal, typical)				
Output Stage Topology	Class-D				
Overload Protection	High temperature, DC, HF, short, voltage limiter, current limiter, inrush current, mains circuit breaker protection				
Physical					
Dimensions	3.5" H x 19" W x 20.7" D (88 mm x 483 mm x 525 mm) - EIA-310 standard width, 2RU height				
Net Weight	24.4 lb (11.1 kg)				
Shipping Weight	30.0 lb (13.6 kg)				
Mounting Depth	21" (533 mm)				
Operating Temperature	32 °F - 104 °F (0 °C - 40 °C)				
Cooling System	Microprocessor-controlled, variable-speed fans, front to rear airflow				

(1) Output power is measured per channel, all channels driven, using test signals at 1 kHz.

(2) Configuration not recommended / not optimal.

(3) Limited use available. Tap 70V loudspeakers 2x the desired power. Tap 100V loudspeakers 4x the desired power. Refer to the application note "Using MONO Mode to Drive High Impedance Loudspeaker Loads."

AC Current Draw and Thermal Dissipation Information

PM8500 / PM8500N, AC Current Draw and Thermal Dissipation							
Test Signal & Power Level	Load Configuration (All Channels Driven)	Total Audio Output, W	120VAC 60Hz. Typical Line Current, A	230VAC 50Hz. Typical Line Current, A	Thermal Dissipation, Typical		
					Watts	BTU/hr.	kCal/hr.
Idle (Standby, Networked)	N/A	0	0.3	0.1	31	106	27
Idle (Awake)	N/A	0	1.3	0.7	176	601	151
1/8th Rated Power IEC65 Bandlimited Pink Noise, 6dB Crest Factor	8Ω/Ch Mono 16Ω/Ch V-Bridge 8Ω/Ch Quad	300	4.2	2.3	205	699	176
	4Ω/Ch Mono 2Ω/Ch I-Share 8Ω/Ch V-Bridge 4Ω/Ch Quad	500	6.4	3.3	272	928	234
1/3rd Rated Power IEC65 Bandlimited Pink Noise, 6dB Crest Factor	8Ω/Ch Mono 16Ω/Ch V-Bridge 8Ω/Ch Quad	800	9.3	4.8	275	938	236
	4Ω/Ch Mono 2Ω/Ch I-Share 8Ω/Ch V-Bridge 4Ω/Ch Quad	1,333	14.9	7.5	455	1,553	391

PM8250 / PM8250N, AC Current Draw and Thermal Dissipation							
Test Signal & Power Level	Load Configuration (All Channels Driven)	Total Audio Output, W	120VAC 60Hz. Typical Line Current, A	230VAC 50Hz. Typical Line Current, A	Thermal Dissipation, Typical		
					Watts	BTU/hr.	kCal/hr.
Idle (Standby, Networked)	N/A	0	0.3	0.1	31	106	27
Idle (Awake)	N/A	0	1.3	0.7	176	601	151
1/8th Rated Power IEC65 Bandlimited Pink Noise, 6dB Crest Factor	8Ω/Ch Mono 16Ω/Ch V-Bridge 8Ω/Ch Quad	250	3.9	2.1	201	686	173
	4Ω/Ch Mono 2Ω/Ch I-Share 8Ω/Ch V-Bridge 4Ω/Ch Quad	250	3.9	2.0	214	730	184
1/3rd Rated Power IEC65 Bandlimited Pink Noise, 6dB Crest Factor	8Ω/Ch Mono 16Ω/Ch V-Bridge 8Ω/Ch Quad	667	8.0	4.2	281	959	242
	4Ω/Ch Mono 2Ω/Ch I-Share 8Ω/Ch V-Bridge 4Ω/Ch Quad	667	8.1	4.1	308	1,051	265

PM4500 / PM4500N, AC Current Draw and Thermal Dissipation							
Test Signal & Power Level	Load Configuration (All Channels Driven)	Total Audio Output, W	120VAC 60Hz. Typical Line Current, A	230VAC 50Hz. Typical Line Current, A	Thermal Dissipation, Typical		
					Watts	BTU/hr.	kCal/hr.
Idle (Standby, Networked)	N/A	0	0.3	0.1	31	106	27
Idle (Awake)	N/A	0	1.0	0.5	114	398	98
1/8th Rated Power IEC65 Bandlimited Pink Noise, 6dB Crest Factor	8Ω/Ch Mono 16Ω/Ch V-Bridge 8Ω/Ch Quad	150	2.6	1.6	130	444	112
	4Ω/Ch Mono 2Ω/Ch I-Share 8Ω/Ch V-Bridge 4Ω/Ch Quad	250	3.4	1.8	162	553	139
1/3rd Rated Power IEC65 Bandlimited Pink Noise, 6dB Crest Factor	8Ω/Ch Mono 16Ω/Ch V-Bridge 8Ω/Ch Quad	400	5.2	3.0	172	587	148
	4Ω/Ch Mono 2Ω/Ch I-Share 8Ω/Ch V-Bridge 4Ω/Ch Quad	667	7.6	3.9	241	822	207

PM4250 / PM4250N, AC Current Draw and Thermal Dissipation

Test Signal & Power Level	Load Configuration (All Channels Driven)	Total Audio Output, W	120VAC 60Hz. Typical Line Current, A	230VAC 50Hz. Typical Line Current, A	Thermal Dissipation, Typical		
					Watts	BTU/hr.	kCal/hr.
Idle (Standby, Networked)	N/A	0	0.3	0.1	31	106	27
Idle (Awake)	N/A	0	0.9	0.5	110	375	95
1/8th Rated Power IEC65 Bandlimited Pink Noise, 6dB Crest Factor	8Ω/Ch Mono 16Ω/Ch V-Bridge 8Ω/Ch Quad	125	2.4	1.5	133	454	114
	4Ω/Ch Mono 2Ω/Ch I-Share 8Ω/Ch V-Bridge 4Ω/Ch Quad	125	2.2	1.1	138	471	119
1/3rd Rated Power IEC65 Bandlimited Pink Noise, 6dB Crest Factor	8Ω/Ch Mono 16Ω/Ch V-Bridge 8Ω/Ch Quad	333	4.6	2.7	178	607	153
	4Ω/Ch Mono 2Ω/Ch I-Share 8Ω/Ch V-Bridge 4Ω/Ch Quad	333	4.2	2.2	173	590	149

Additional Resources

Visit us on the web at **pro.Bose.com** for more information, including specifications, technical literature, product warranty, parts and accessories, and global support contact information.

Date of Manufacture: The eighth digit in the serial number indicates the year of manufacture; “7” is 2007 or 2017.

China Importer: Bose Electronics (Shanghai) Company Limited, Level 6, Tower D, No. 2337 Gudai Rd. Minhang District, Shanghai 201100

UK Importer: Bose Limited Bose House, Quayside Chatham Maritime, Chatham, Kent, ME4 4QZ, United Kingdom

EU Importer: Bose Products B.V., Gorslaan 60, 1441 RG Purmerend, The Netherlands

Mexico Importer: Bose de México, S. de R.L. de C.V. , Paseo de las Palmas 405-204, Lomas de Chapultepec, 11000 México, D.F. For importer & service information: +5255 (5202) 3545

Taiwan Importer: Bose Taiwan Branch, 9F-A1, No. 10, Section 3, Minsheng East Road, Taipei City 104, Taiwan.
Phone Number: +886-2-2514 7676

Bose Corporation Headquarters: 1-877-230-5639

©2022 Bose Corporation. No part of this work may be reproduced, modified, distributed or otherwise used without prior written permission.



855982-0020

BOSE[®]
Better sound through research[®]

©2022 Bose Corporation. All rights reserved.
The Mountain, Framingham, MA 01701-9168 USA
PRO.BOSE.COM
All trademarks are the property of their respective owners.
AM855982 Rev. 01