

4K/UHD 5 Input HDMI Switcher with Mirrored HDMI and HDBaseT Outputs and PoE

AT-UHD-SW-52ED
User Manual



Please check <http://www.atlona.com/product/AT-UHD-SW-52ED>
for the most recent **firmware
update** or **manual**.

Table of Contents

1. Introduction	3
2. Package Contents	3
3. Features	3
4. Category Cable	4
4. Panel Descriptions	
a. Front	5
b. Back	5
5. Remote Control	5
6. Captive Screw	6
7. Audio	7
8. TCP/IP	8-16
9. RS-232 & TCP/IP	
a. Terminal	17
b. Connection	17
c. Commands	18-19
d. Baud Rate	19
e. IP Commands	20
f. 3rd Party Control	20
10. Connection Diagram	21
11. Specifications	22
12. Safety	23
13. Warranty	24-25
14. Registration	25

Introduction

The 4K/UHD 5 input HDMI switcher with mirrored HDMI and HDBaseT output supports 4K @ 60Hz, Ethernet transmission/support/management, RS-232, IR, and TCP/IP control along with a webGUI for easy set up. Built in display control enables the switcher to automatically turn the display on/off (through TCP/IP or RS-232), control volume, and more. With control, audio de-embedding, and EDID/HDCP management the UHD-SW-52ED will ensure the best audio and video experience.

Package Content

- 1 x UHD-SW-52ED
- 1 x 48V DC power supply (AT-PW48V0.83A-CAPT)
- 4 x Female captive screw connector (5pin: analog audio & IR, 3 pin: RS-232, and 2 pin: power)
- 1 x Short rack ear
- 1 x Long rack ear
- 2 x Mounting plates
- 1 x Remote control
- 4 x Rubber feet
- 1 x User Manual

Features

- Mirrored HDMI and HDBaseT output
- Automatic display control using TCP/IP/RS-232 commands, or CEC
- Auto switching with video detection technology (activated through RS-232 or webGUI)
- Analog audio de-embedding through captive screw connector
- +4 dBu balanced analog audio output
- Control volume using webGUI, IR, TCP/IP, or RS-232
- Supports 4K @ 60Hz 4:2:0 or 4K @ 30Hz RGB with 8 bit color
- Supports Dolby® TrueHD and DTS-HD Master Audio™ when using an HDMI for audio input and output
- Digital audio de-embedding through the S/PDIF output for up to DTS™ 5.1 and Dolby® Digital
- Extended distance HDBaseT port w/PoE to power compatible receivers up to 100 meters (328 feet) away
- HDCP management
- EDID management
- Easy to use webGUI through Ethernet connection
- Half-rack size
- Comes with rack mount ears and mounting plates

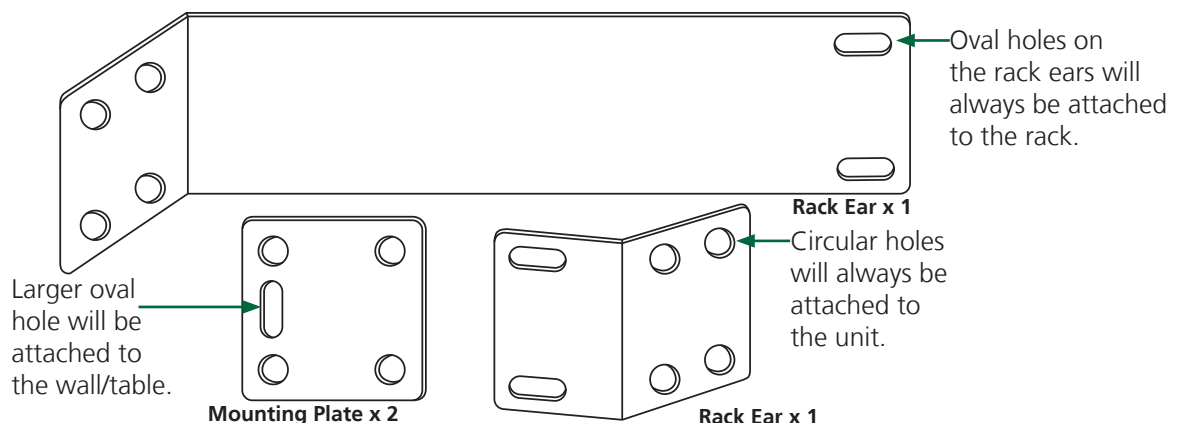

The UHD-SW-52ED can be mounted in three ways: as a single unit in a rack, with a second unit in a rack, or against a wall/table using the mounting plates.

Single unit mounting will use the long rack ear and short rack ear to affix the unit to the rack.

Two unit mounting will use two short rack ears (the second will be in the box with the second unit) and two mounting plates to affix the two units together inside the rack.

Wall/table mounting will use both mounting plates to affix the unit to a table or wall.

Category Cable

For the category cables used in the installation of these products, please be sure to use a 568B termination as pictured below:

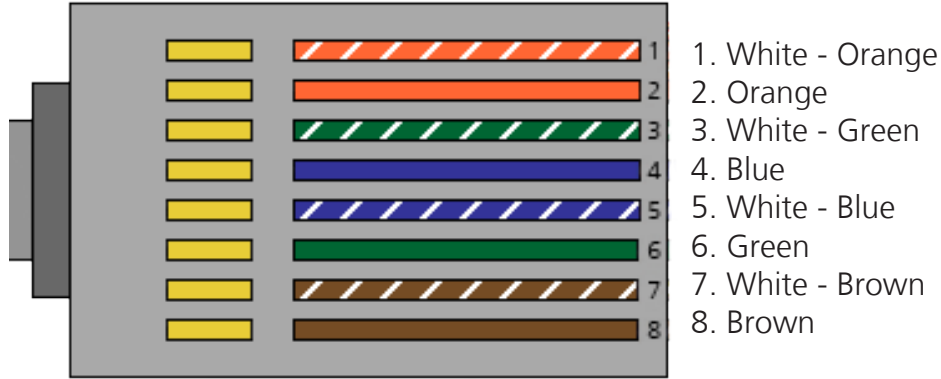

Use the table below to verify the best category cable for the installation.

Performance Rating		Type of LAN cable	
Wiring	Shielding	CAT5e/6	CAT6a/7
Solid	Shielded (STP/FTP)	***	****
	Unshielded (UTP)	**	N/A
Stranded - Patch cable (Not recommended)	Unshielded (UTP)	*	N/A
	Shielded (STP/FTP)	*	N/A
Termination		Please use EIA/TIA-568-B termination	

Important! 4K (UHD) signals are sensitive to cable quality and installation technique. It is recommended to use CAT6a/7 solid core cables for best results.

Note: For cable distances see the specifications on page 20

Connector

Connector type and size is very important to ensure extenders work correctly. Please use the matching cable type with the correct RJ45 connector.

CAT5e cables should use only CAT5e RJ45 connectors

CAT6 cables should use only CAT6 connectors

CAT6a cables should use only CAT6a connectors

CAT7 cables should use only CAT7 connectors

Using the wrong size connectors may result in interference causing loss of signal.

Important! "EZ RJ45 connectors" are not recommended with HDBaseT extenders. Doing so may result in interference with audio and video transmission.

Panel Descriptions

Front Panel

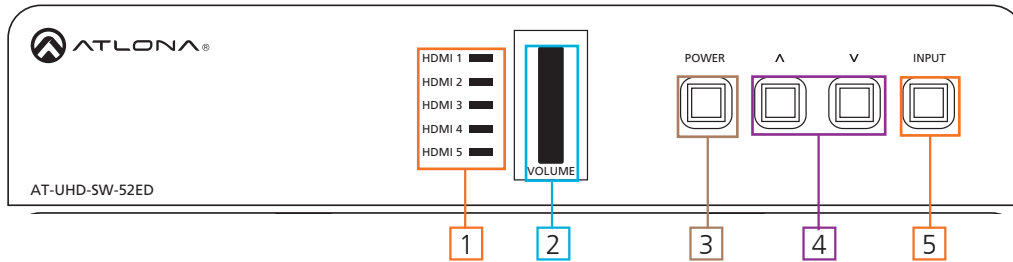

1. HDMI LEDs - Illuminates to indicate the selected source
2. Volume LEDs - Displays the volume level
3. Power Button - Turns switcher on, places the unit in standby mode, or control a connected display through the HDBaseT output
4. Volume up/down - Adjusts output volume or display volume through the HDBaseT output
5. Input Button - Switches between HDMI inputs

Back Panel

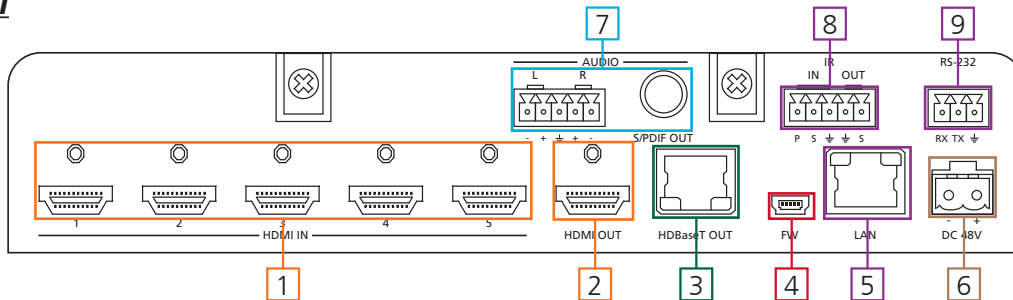

1. HDMI IN - Connect sources here
2. HDMI OUT - Connect to an HDMI display, extender, or switcher
3. HDBaseT OUT - Connect to an HDBaseT PoE receiver (e.g. AT-UHD-EX-100CE-RX)
4. FW port: Firmware update port, connect a Mini USB to USB A cable to a computer
5. LAN port - Connect network switch or router to this port for Ethernet, TCP/IP, or webGUI control
6. DC 48V: Connect included captive screw, 48V DC power supply here
7. Audio output - Connect to an amplifier, mixer, DSP, audio receiver, or other audio device
8. IR port - Connect IR control system or compatible IR emitter/receiver to this port
9. RS-232 port - Connect control system to RS-232 port

Remote Control

1. Power On/Off: Turn switcher power on and off
2. Video On/Off: Turns video output off and on
3. Input selection: Selects source
4. Audio control: Adjust volume up/down
Mute: Mute output audio

Note: Setup buttons are not functional for the UHD-SW-52ED switcher

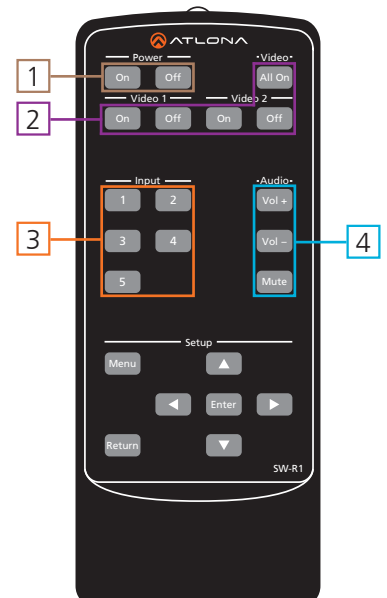

Captive Screw

The captive screw connectors allow you to cut cables to a suitable length, reducing cable clutter while providing a more reliable connection.

Connecting

When connecting the cables to the female captive screw connector it is important that the wires be terminated correctly. The female captive screw connector has a contact plate at the top and must have the wires touching it for signal to pass. When wired correctly (see picture A) the signal will pass, incorrectly (see picture B) no signal will pass.

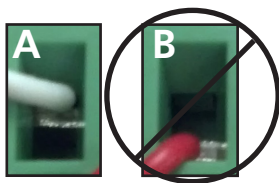

The captive screw connectors have a contact bar that is adjusted to compress the wire against the top contact plate. Use the screws at the top of the connector to compress the wire against the contact plate.

 Clockwise
Turn the screws clockwise to raise the contact bar to the upper contact plate and hold the wires in place.

 Counter Clockwise
Turn the screws counter clockwise to lower the contact bar to release the wires.

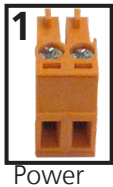

Power

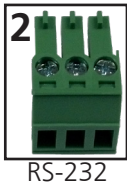

RS-232

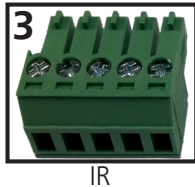

IR

Female captive screw connectors are included: Power (see picture 1), RS-232 (see picture 2), and IR (see picture 3).



Black: - White: +

The power cable (picture 4) will have exposed wires. Each wire is encased in a different colored cover.

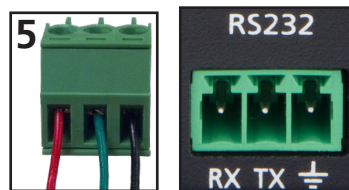

Pin out color will differ per RS-232 cable.

RS-232 pin out will be determined by the RS-232 cable and will connect as Rx (receiver), Tx (transmitter), and \perp (ground). (See picture 5)

Note: The IR receiver and IR transmitter is optional for the UHD-SW-52ED. The compatible IR receiver (AT-IR-CS-RX) and IR transmitter (AT-IR-CS-TX) can be purchased through atlona.com.

The wires of the emitter and receiver have been marked to differentiate the pin outs.

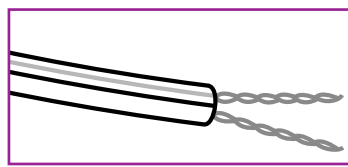
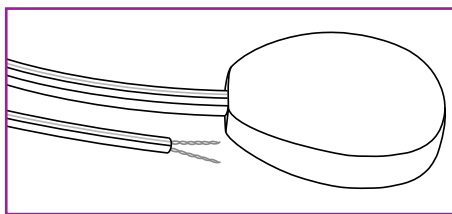

— Signal (S)
— Ground (\perp)

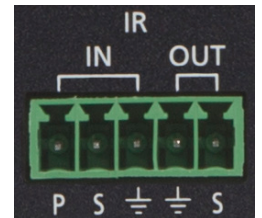

The included IR emitter has two wires: signal and ground. Signal will have a solid line and ground will be blank. The IR emitter will plug into the IR OUT ports.

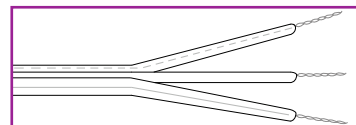
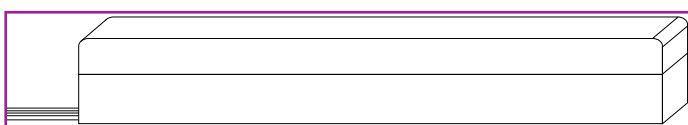

— Signal (S)
— Ground (\perp)
— Power (P)

There are three wires on the IR receiver (sold separately): signal, ground, and power. Signal has a dotted line, ground will be blank, and power will have a solid line. The IR receiver will plug into the IR IN ports.

Analog Audio

A captive screw analog audio connector is provided to ensure a more reliable and secure connection. The captive screw connector supports balanced and unbalanced audio output.

Balanced audio connections use two signal wires and a ground to minimize interference to audio signals. Unbalanced audio connections use one signal wire and a ground and are used if other system components don't support balanced signals.

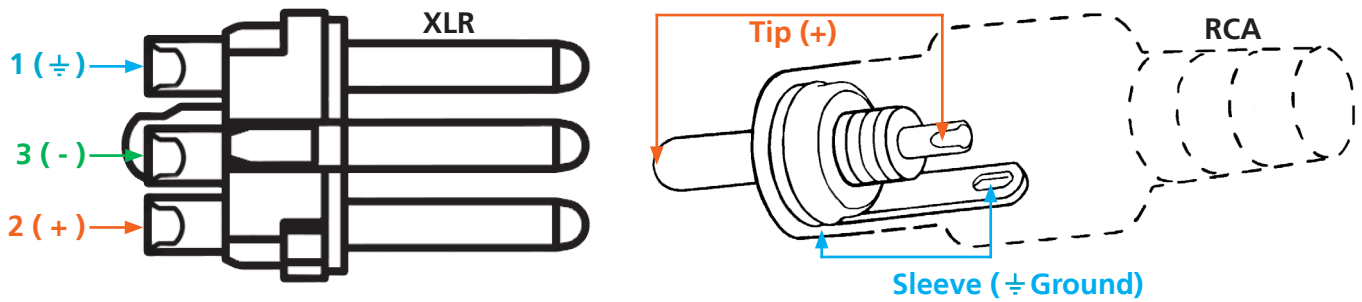

Note: Pin outs may vary, please refer to the audio device's manual to ensure a correct connection.

Important! When terminating cables, please ensure exposed adjacent wires do not touch. This may result in a short that can damage connected devices.

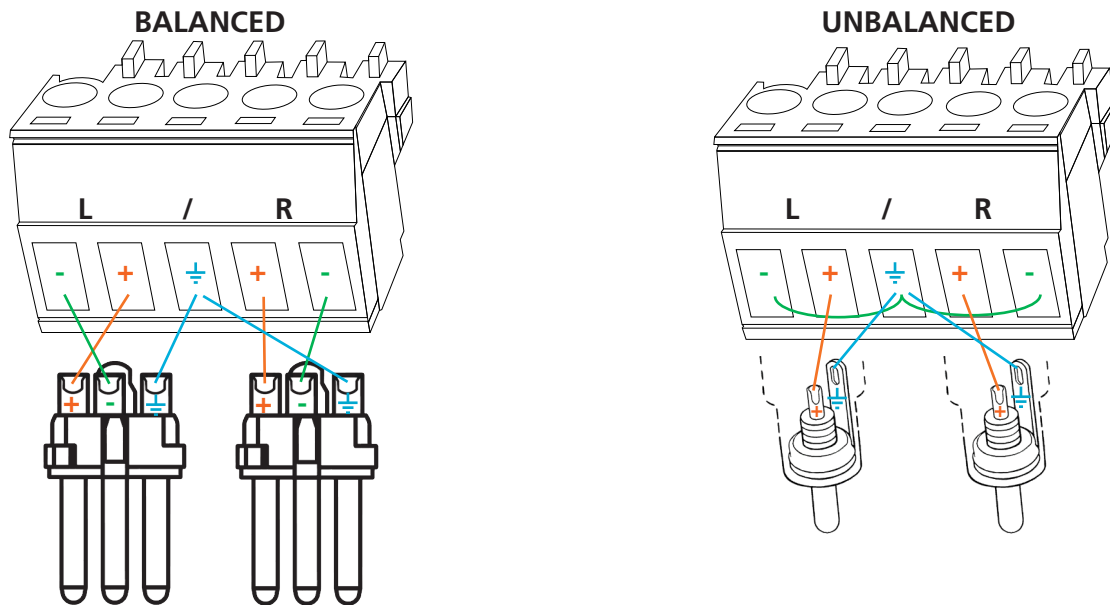

Important! With unbalanced connections a jumper is needed between ground and negative to reduce noise

Ethernet

For convenience, the UHD-SW-52ED comes with DHCP on. This enables the switcher to be connected to a network without knowing available IP addresses. If your network does not allow dynamic IP addresses or if you are using the switcher with a TCP/IP control system, this feature may be turned off and the IP address set using RS-232 commands or the webGUI.

WebGUI

Atlona has created an easy to use webGUI for initial setup and later changes to the configuration of the switcher.

To begin, plug a LAN cable into the LAN port of the UHD-SW-52ED and the network switch, then type the IP address of the unit into a web browser of a PC connected to the same network (as seen below).

To find the switcher IP: use RS-232 command "IPCFG".

Note: IP addresses may also be found using common free IP scanner software such as "Advanced IP Scanner"

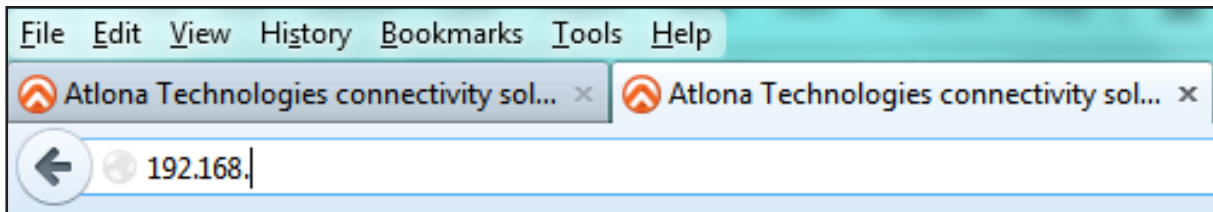

Important: If any stability issues are experienced, disable any anti-virus or firewall that may interfere with network communication to the switcher. Once set up is done and the switcher webGUI is no longer used, the firewall and anti-virus can be re-enabled.



AT-UHD-SW-52ED Login



Please input username and password.

Username:

Password:

[Login](#)

[Clear](#)

A login screen will appear (this is the same log in for admin and general users). For the first log in (and future admin changes) the username is "root" and password is "Atlona".

Note: Only the admin password can be changed (see page 9). The username will always remain "root".

The home screen tab will display the general system information.

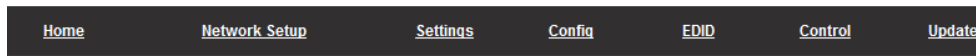

System Info.	
Model:	AT-UHDSW-52ED
Firmware Version:	0.2.0
On-Time(h-m):	0:03

Video Info.	
Active Input:	HDMI2
Signal Type:	--
Video Format:	--
Aspect:	--
Color Space:	--
Color Depth:	--



DHCP	<input checked="" type="checkbox"/> ON <input type="checkbox"/> OFF
IP Address	<input type="text" value="192.168.000.078"/>
Subnet	<input type="text" value="255.255.255.000"/>
Gateway	<input type="text" value="192.168.000.001"/>
Telnet Port	<input type="text" value="23"/>
Login Mode	<input type="checkbox"/> ON <input checked="" type="checkbox"/> OFF
MAC Address	B8-98-B0-00-00-09

The Network Setup Page will allow the IP information to be changed. When a change is made the screen will grey and the ability to save or cancel will display at the bottom.

Note: When DHCP is on, the IP address cannot be configured. Turn DHCP off to enable IP configuration.

Note: For a stable connection when using a control system, it is best to set up a static IP. As you select an IP address, make certain no other devices on your network are using that IP address.

Login Mode has been added to provide a secure telnet login. Once Login Mode has been turned on a username and password will be required on all IP connections to the switcher.

Note: Login mode should be in off position when the UHD-SW-52ED is used with control systems that do not support passwords. If your control system supports password protection, you can turn login mode on. The webGUI always requires a password.

Note: The username and password used in IP Login Mode will be the same login information as the webGUI.

[Home](#) [Network Setup](#) [Settings](#) [Config](#) [EDID](#) [Control](#) [Update](#)

System Settings

Auto Switch

Video Settings

Source

Audio Settings

Volume dB 

System Settings

Auto Switch - Turn auto switching on/off. Default is off.

Video Settings

Source - Select one of the five inputs to be routed to the output.

Audio Settings

Volume - Adjust output volume up or down

Change user name and password:

Old user name and password	
Username	<input type="text" value="root"/>
Password	<input type="password"/>
New user name and password	
Username	<input type="text"/>
Password	<input type="password"/>
PW again	<input type="password"/>

No.	Username	Password	Delete
User 1			Delete
User 2			Delete
User 3			Delete

RS-232	Baudrate	Databit	Parity	Stopbit
System	115200	8 Bits	None	1 Bit
Zone 1	115200	8 Bits	None	1 Bit

[Factory Default](#)

The Config Page will allow the admin password to be changed, users to be added, and the RS-232 ports to be configured.

Note: User information will display for the admin only. Up to 3 users other than admin can be added.

Note: Only the admin password can be changed. The username will always remain "root". If the admin password is lost the system must be returned to factory settings and setup repeated.

RS232	Baudrate	Databit	Parity	Stopbit
System	115200	8 Bits	None	1 Bit

Factory Default

[Save Settings](#)

[Cancel](#)

EDID Settings

Input 1:

Input 2:

Input 3:

Input 4:

Input 5:

HDCP Settings

Input 1:

Input 2:

Input 3:

Input 4:

Input 5:

EDID Saved

Output 1: save to

Output 2: save to

The EDID Page enables the input preferred timing to be selected and HDCP compliance reporting to be set.

Note: To ensure compatibility, it is best to set the EDID to match the native resolution of the connected display and the audio format of the connected sound system

Note: To use the analog audio output, a 2Ch EDID will need to be selected

Internal EDIDs -

STD Sink (pass through)	Int_1 1080P 2Ch	Int_2 1080P MCh
Int_3 1080P DD	Int_4 1080P 3D 2Ch	Int_5 1080P 3D MCh
Int_6 1080P 3D DD	Int_7 720P 2CH	Int_8 720P DD
Int_9 1280x800 2Ch	Int_10 1366x768 2Ch	Int_11 1080P DVI
Int_12 1280x800 DVI	Int_13 3840x2160 2Ch	Int_14 3840x2160 MCh

Note: Internal EDIDs include audio EDIDs as well. 2Ch is two channel audio, MCh is multi-channel audio (including up to Dolby TrueHD or DTS-HD Master Audio), DD is Dolby Digital, and DVI does not include audio.

HDCP selection allows the HDCP reporting of the input to be changed between compliant and non-compliant

Note: This function is controllable through RS-232 and TCP/IP.

Note: UHD-SW-52ED protects HDCP encoded content and will not pass HDCP content to a non-HDCP compliant device.

Note: Some devices flag all content as protected when connected to an HDCP compliant display. This prevents what should be non-protected content from reaching devices (e.g. teleconference system) through the UHD-SW-52ED.

Note: When HDCP reports as non-compliant, only user created content is transmitted. Protected content from all sources (e.g. Blu-ray, AppleTV, etc) is blocked.

EDID Saved

Save the current output's EDID to memory. There are eight total EDID memories to save to.

Home
Network Setup
Settings
Config
EDID
Control
Update

Button Control Selection

Power	CEC
Volume/Mute	Audio Out

CEC Control

Power	on	off
-------	----	-----

The Control Page includes settings which enable display controls by the switcher. It provides a way to program button functions, turn auto switching on/off, and determine the type of control commands (TCP/IP or RS-232) sent out.

Button Control Selection

Power - Set which device the power button controls

None: Power button will turn the UHD-SW-52ED on and off

RS-232: Power button will send power on/off command over HDBaseT using RS-232 to compatible receivers and displays

IP: Power button will send power on/off command over Ethernet using either the LAN connection or the HDBaseT connection

Volume/Mute

Audio Out: Volume and mute buttons will control volume output of the switcher

RS-232: Volume/Mute buttons will send the commands over HDBaseT using RS-232 to compatible receivers and displays

IP: Volume/Mute buttons will send the commands over Ethernet using either the LAN connection or the HDBaseT connection

CEC Control

Power

On - Sends a command over HDBaseT to the HDMI output of the connected receiver to turn the connected display on

Off - Sends a command over HDBaseT to the HDMI output of the connected receiver to turn the connected display off

Note: CEC may not work with every display type. See the note below.

Consumer Electronics Control (CEC): Atlona has confirmed proper CEC functionality with several current models of Samsung, Panasonic, and Sony displays. However, it is not guaranteed that CEC will work with all displays. Many manufacturers do not support the CEC "off" command, and older displays use proprietary commands. Atlona only supports displays that use the CEC command structure defined in HDMI 1.2a. It is recommended that dealers request an evaluation product from Atlona, before designing a system using the CEC protocol. If this is not possible, then other control methods will need to be considered, in order to control displays using Atlona products.

System Settings		
Display Auto Power On	<u>Enabled</u>	<u>Disabled</u>
Display Auto Power Off	<u>Enabled</u>	<u>Disabled</u>
Power Button Lock	<u>Enabled</u>	<u>Disabled</u>
Lamp Cool Down Timer (0~300)	10 Sec	<u>Save</u>
Auto Power Off Timer (10~240)	10 Sec	<u>Save</u>
Display Warm Up Timer (0~300)	10 Sec	<u>Save</u>
Control Type	CEC	
Feedback Verify	ON	

System Settings

Display Auto Power On - When enabled, the unit will send a programmed command to the display to turn on after detecting an A/V signal

Display Auto Power Off - When enabled, the unit will send a command to the display to turn off after not detecting an A/V signal

Lamp Cool Down Timer (10-300) - Used with a projector whose lamp cannot be turned on for up to 5 minutes after being shut off. Match settings with lamp delay on projector

Auto Power off timer (10-240) - Sets the period of time between the loss of A/V signal and when the "Display Off" command is sent

Note: LED will blink red for the auto power off time period then go solid

Note: All functionality remains, only the HDBaseT output is turned off

Display Warm Up Timer (10-300) - Sets the period of time after the display is turned on, that the power button will be locked

Note: LED will blink green for the warm up timer period and then stay solid

Note: When timers are set to 0 seconds, they will disable the timers' functions

Control Type - Select whether the display on/off commands are sent using RS-232, TCP/IP, or CEC

Feedback Verify

On: If receiving no feedback, the product will send the command up to 4 times

Off: The command will only be sent once, whether feedback is received or not

TCP/IP Settings of Controlled Device	
IP Mode	Non-Login <input type="button" value="Save"/>
IP Address	0.0.0.0 <small>Please set your device to static IP address.</small>
Port	23
Username	<input type="text"/>
Password	<input type="text"/>

RS-232/IP Commands	
<input checked="" type="radio"/> ASCII	<input type="radio"/> Hex <input type="button" value="Save"/>
<input type="button" value="Test"/> On	
PW 1	CR-LF ▾
Feedback	
PW 1	CR-LF ▾
<input type="button" value="Test"/> Off	
PW 0	CR-LF ▾
Feedback	
PW 0	CR-LF ▾
<input type="button" value="Test"/> Volume+	
VOL+	CR-LF ▾
<input type="button" value="Test"/> Volume-	
VOL-	CR-LF ▾
<input type="button" value="Test"/> Mute	
MUTE	CR-LF ▾
Feedback	
MUTE	CR-LF ▾

TCP/IP Settings of Controlled Device

This option sets the IP for display control. The static IP set here should match the display's static IP. To set or view the display's IP address, check the display's user manual.

Note: The switcher and the display must be on the same network for these commands to work

Note: Be sure the static IP address set for the display does not match any other device on the network

IP Mode

Non-login: Does not require a username and password when using TCP/IP to control the display

Login: Requires a username and password to control the display through TCP/IP

IP Address & Port - Set to match the display's static IP

Username & Password - Required when in login mode

Save - Saves the IP settings for accessing the controlled device

RS-232/IP Commands

ASCII/Hex - Set which type of commands are sent to the display

On/Off/Volume+/Volume-/Mute - Enter the specific commands and feedback that will be sent/received when using any of the control options

Note: Individual commands will be found in the display's manual

End of line symbols - None, CR, LF, CR-LF, Space, STX, ETX, Null - Select the appropriate symbol from the drop down list. Carriage return, line feed, and carriage return with line feed are the most commonly used symbols.

Note: Be sure to check the display's manual for the correct symbol

Firmware Update
 No file selected.

0%

Valens Tx Update
 No file selected.

0%

For the best performance ensure the most current firmware is being used. Atlona frequently updates firmware to add features, improve compatibility, and fix bugs. If any issues are experienced with the switcher, check to make sure the most current firmware is installed.

Download the latest firmware from <http://www.atlona.com/AT-UHD-SW-52ED> to a specific place on the computer, unzip the firmware file, then update the unit using the browse and upload buttons.

Click the browse button and select the firmware to be loaded from the PC. Once selected, press the upload button. The progress bar displays the progress of the firmware update.

The Valens (HDBaseT) port has a separate firmware. This firmware can be found at <http://www.atlona.com/AT-UHD-SW-52ED>.

Click the browse button and select the Valens (HDBaseT) file that was downloaded. Once selected, press the upload button, the progress bar displays the progress of the firmware update.

RS-232 & TCP/IP

Terminal

To set up the RS-232 terminal the first thing needed is to find the RS-232 communications port under the computer's device manager. Once there, right click the port and select "Properties". Under the properties menu select the port settings tab and set the menu to the switcher default: Bits per second: 115200, Data bits: 8, Parity: None, Stop bits: 1 and Flow control: None.

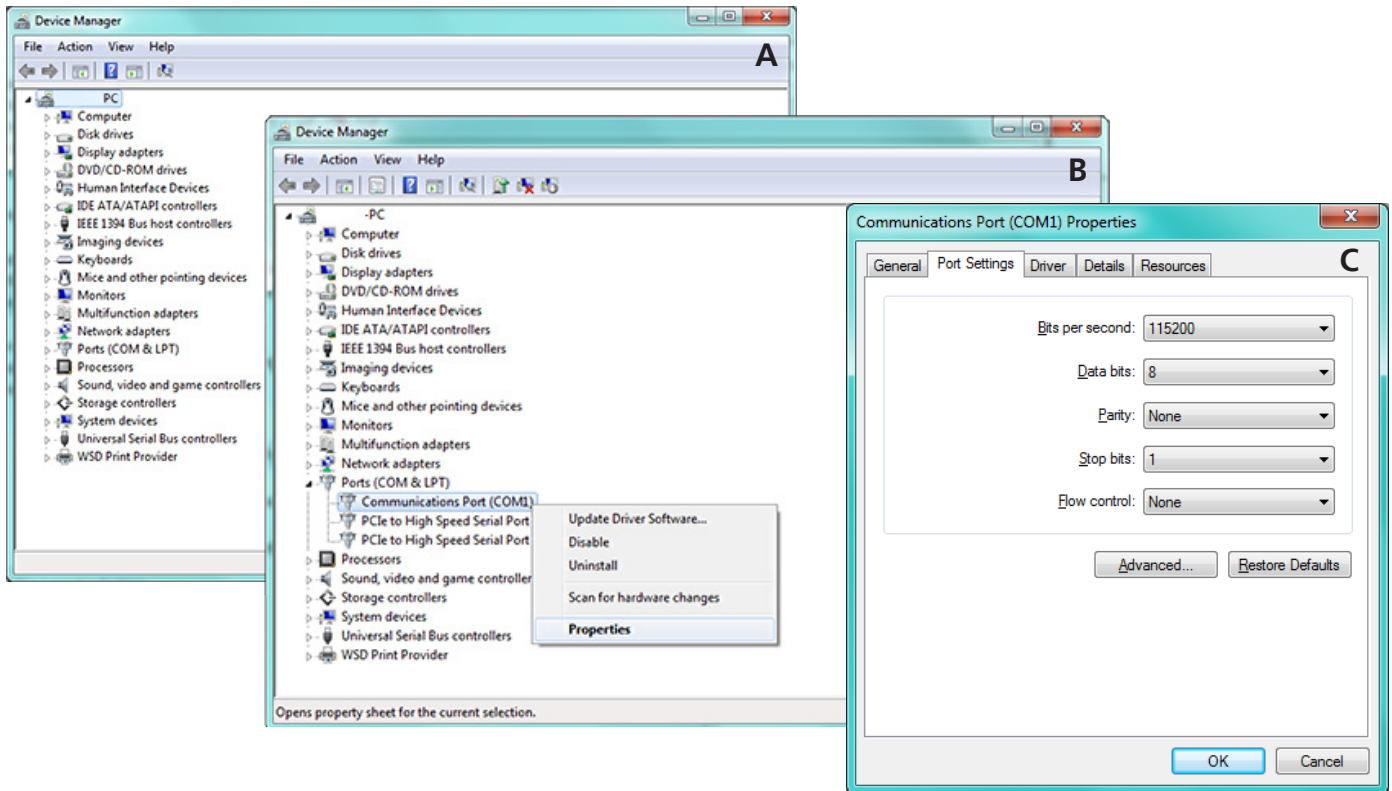

Connection

RS-232 is connected through a 9-pin female D connector. Three pins will have specific functions associated with them, some are unassigned.

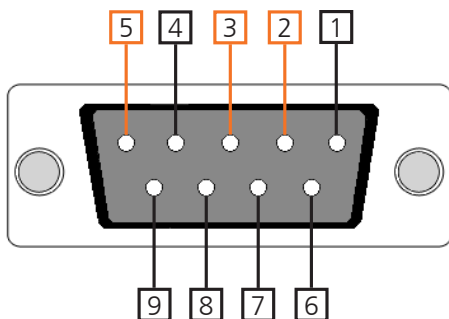

No.	Pin	Function
1	---	Not used
2	Tx	Transmit
3	Rx	Receive
4	---	Not used
5	Gnd	Ground
6	---	Not used
7	---	Not used
8	---	Not used
9	---	Not used

Commands (TCP/IP and RS-232)

The command codes are case sensitive, do not change capitalization, spacing, or lettering.

Command	Feedback	Description
PWON	PWON	Turns switcher on
PWOFF	PWOFF	Turns switcher off
PWSTA	PWSTA	Displays power status
VersionX E.g. Version OSD	VersionX E.g. Version x.x.xx	Displays the software versions: ex. VersionMCU firmware [MCU] OSD menu [OSD] DSP [DSP] FPGA [FPGA]
Type	AT-UHD-SW-52ED	Displays the model information
REBOOT	REBOOT	Reboots the AT-UHD-SW-52ED
Mreset	Mreset	Reset device to manufacture default
Lock	Lock	Locks the front panel buttons
Unlock	Unlock	Unlocks the front panel buttons
x3AVx1	x3AVx1	Switch inputs Ex. Switch output 1 to input 4= x4AVx1
Status	x2AVx1, x3AVx2	Displays what input is connected to the what output
x1\$ X	x1\$ on	Turns on/off output channel (X= on, off, sta) E.g. x2\$ off - Turns output 2 off
AutoSW X	AutoSW on	Turns auto switching on/off (X= on, off, sta)
IRON	IRON	Turns on the IR receiver window
IROFF	IROFF	Turns off the IR receiver window
EDIDCopyX memY E.g. EDIDCopy1 mem2	EDIDCopyX memY E.g. EDIDCopy1 mem2	Save the EDID of output X (1 or 2) to memory Y (1-8) E.g. Copy EDID of output 2 to memory 5 = EDIDCopy2 mem5
EDIDMSetX default	EDIDMSetX default	Set the EDID of the input to the default EDID
EDIDMSetX saveY	EDIDMSetX saveY	Set the EDID of an input to the previously saved EDID memory E.g. EDIDMset3 save1 - sets input 3 to EDID memory 1
EDIDMSetX intY	EDIDMSetX intY	Sets the EDID of an input to one of the internal EDIDs E.g. EDIDMSet2 int3 - Sets input 3 to internal EDID 3
HDCPSetX Y E.g. HDCPSet1 on	HDCPSetX Y E.g. HDCPSet1 on	Set HDCP reporting mode of the HDMI input (X= 1-5)(Y= on, off, sta) E.g. Input 3 to report HDCP non-compliant = HDCPSet3 off
AudioOutX Y	AudioOutX on	Turns the HDMI audio of each output (X= 1, 2) on/off (Y= on, off, sta) E.g. Turn Output 2 HDMI audio off = AudioOut2 off
VOUT1 +	VOUT1 XX	Increases volume output by 1
VOUT1 -	VOUT1 XX	Decreases volume output by 1
VOUT1 YY E.g. VOUT1 -60	VOUT1 XX E.g. VOUT1 -60	Set volume output to a specific value (XX= -80 to 6)
VOUT1 sta	VOUT1 YY	Displays current volume output
VOUTMute1 X	VOUTMute1 X	Mute or unmute the output volume (X= on, off, sta)

Each command or feedback is terminated with a carriage return.

Note: If the command fails or is incorrect the feedback is "Command FAILED"

[Y] preferred timing -

STD Sink (pass through)	1	1080P 2Ch	2	1080P MCh
3 1080P DD	4	1080P 3D 2Ch	5	1080P 3D MCh
6 1080P 3D DD	7	720P 2CH	8	720P DD
9 1280x800 2Ch	10	1366x768 2Ch	11	1080P DVI
12 1280x800 DVI	13	3840x2160 2Ch	14	3840x2160 MCh

Note: Preferred timings include audio EDIDs as well. 2Ch is two channel audio, MCh is multi-channel audio (including up to Dolby TrueHD or DTS-HD Master Audio), DD is Dolby Digital, and DVI does not include audio.

Command	Feedback	Description
SetCmd x[y] e.g. SetCmd on[PWR ON]	SetCmd x[y] e.g. SetCmd on[PWR ON]	Sets the RS-232 or IP command for the selected button or function x = on, off, vol+, vol-, and mute y = command e.g. Set the on command to send the command PWR ON
SetEnd x[y] e.g. SetEnd off[CR-LF]	SetEnd x[y] e.g. SetEnd off[CR-LF]	Sets the line termination for the chosen command x = on, off, vol+, vol-, mute, fbkon, fbkoff, fbkmute y = None, CR, LF, CR-LF, Space, STX, ETX, and null e.g. Set the command off to have a carriage return and line feed
TrigCEC y e.g. TrigCEC on	TrigCEC y e.g. TrigCEC on	Triggers the stored CEC command to turn the display on and off y = on, off
TrigRS y e.g. TrigRS vol+	TrigRS y e.g. TrigRS vol+	Triggers the RS-232 command from RS-232 or IP y = on, off, vol+, vol-, and mute
TrigIP y e.g. TrigIP vol-	TrigIP y e.g. TrigIP vol-	Triggers the IP command from RS-232 or IP y = on, off, vol+, vol-, and mute
CtlType x e.g. CtlType rs-232	CtlType x e.g. CtlType rs-232	Sets the control type x = ip, rs-232, cec e.g. Set the control type to RS-232
CliMode x e.g. CliMode non-login	CliMode x e.g. CliMode non-login	Sets the control device's IP mode x = sta, login, non-login e.g. Sets the IP mode to non-login
CliUser x e.g. CliUser	CliUser x e.g. CliUser admin	Sets the IP username for login x = username, (blank) e.g. Display the IP username by leaving x blank
CliPass x e.g. CliPass AtlonA	CliPass x e.g. CliPass AtlonA	Sets the IP password for login x = password, (blank) e.g. Set the IP password to AtlonA
CliIPAddr x e.g. CliIPAddr sta	CliIPAddr x e.g. CliIPAddr 192.168.0.23	Sets the IP address of the controlled device x = ip, sta e.g. Display the IP address of the controlled device
CliPort x e.g. CliPort 24	CliPort x e.g. CliPort 24	Sets the IP port of the controlled device x = port, sta e.g. Set the IP port to 24
LampCool x e.g. LampCool 120	LampCool x e.g. LampCool 120	Sets the lamp cool-down duration, in seconds. Match this setting with the lamp delay on the projector (X= 0 to 300)
SetOff x e.g. SetOff 60	SetOff x e.g. SetOff 60	Sets the time interval, in seconds, between the loss of A/V signal and when the "Display Off" command is sent (X= 10 to 240)
DisWarmUp x e.g. DisWarmUp 60	DisWarmUp x e.g. DisWarmUp 30	Sets the time interval, in seconds, after the display is turned on, that the power button will be locked (X= 0 to 300)

Baud Rate

Default baud rate to control the switcher is 115200 and default baud rate to control the display or projector is 9600. **Note:** For the display's actual baud rate, refer to the owner's manual

To change the baud rate of the switcher (for switcher control) or the zone output (for display/projector control), the commands below will be needed

Switcher parameter command

CSpara[baudrate,data-length,parity,stop-bit] (data-length, parity, and stop-bit for switcher must be 8,0,1)

Example: To change the baud rate to 38400 use **CSpara[38400,8,0,1]**

Note: Use this command if the connected control system does not output 115200

Zone output parameter commands (for display control)

RS232para1[baudrate,data-length,parity,stop-bit]

Example: To change the output baud rate to 19200 use **RS232para1[19200,8,0,1]**

Note: Use this command if the connected display uses a different baud rate

RS232zone1[command]

Once the switcher and zone output have been set up for the best communication, commands can be sent to control the display. The commands will come from the user manual of the display or projector. The commands and any carriage returns/line feeds in the commands will need to be placed in the bracket.

Example: To turn the display or projector on if the command is PWRON carriage return, use the command:
RS232zone1[PWRON carriage return]

IP Commands

Command	Feedback	Description
IPCFG	IP Addr : x.x.x.x Netmask : x.x.x.x Gateway : x.x.x.x IP Port : x	Displays IP address configuration
IPQuit	IPQuit	Logs out of TCP/IP Connection
IPAddUser X Y E.g. IPAddUser Atlona 1234	TCP/IP user was added	Adds a user for TCP/IP control X= user and Y= Password
IPAddUser	username password username password username password	Displays a list of users and passwords
IPDelUser X	TCP/IP user was deleted	Delete a user from TCP/IP X= username
IPDHCP X	IPDHCP X	Turns DHCP on or off X= on, off, sta
IPStatic X Y Z E.g. IPStatic 192.168.1.1 255.255.255.0 192.168.1.200	IPStatic X Y Z E.g. IPStatic 192.168.1.1 255.255.255.0 192.168.1.200	Sets static IP address IPStatic Address(X) Netmask(Y) Gateway(Z)
IPPort X	IPPort X	Set the TCP/IP Port
IPLogin X E.g. IPLogin off	IPLogin X E.g. IPLogin off	Enables IP Login X= on, off, sta
Broadcast X E.g. Broadcast on	Broadcast X E.g. Broadcast on	Sets broadcast mode on or off X= on, off, sta
InputBroadcast x E.g. InputBroadcast on	InputBroadcast x E.g. InputBroadcast on	Sets the input broadcast reporting status X= on, off, sta
InputStatus E.g. InputStatus	InputStatus E.g. InputStatus 11001	Displays the input status for each input 1 = active input, 0 = no source connection
InputStatusX E.g. InputStatusX	InputStatusX Y E.g. InputStatus2 1	Displays the input status for the specified input. X= input number, and Y is returned for the source status: Y=0 is no source connection, Y=1 is active input
IPTimeout XX E.g. IPTimeout 300	IPTimeout XX E.g. IPTimeout300	Determines amount of seconds of inactivity before TCP/IP disconnects

Each command or feedback is terminated with a carriage return.

Note: If the command fails or is incorrect the feedback is "Command FAILED"

3rd Party Control

The UHD-SW-52ED is compatible with most 3rd party control systems. TCP/IP and RS-232 commands can be passed from 3rd party control systems to the UHD-SW-52ED through the LAN or RS-232 port.

Note: The switcher can also convert TCP/IP commands to RS-232 commands which are then sent to the compatible HDBaseT devices.

The UHD-SW-52ED can take either TCP/IP or RS-232 command protocol and transmit it to a connected device: saving labor, cable, and control system ports.

The RS232zone command re-transmits RS-232 commands to the display through the compatible HDBaseT receiver. The command may be initiated using either RS-232 or TCP/IP commands.

The Display On/Off command may be used to transmit a TCP/IP command by either RS-232 or TCP/IP to a display.

Connection Diagram

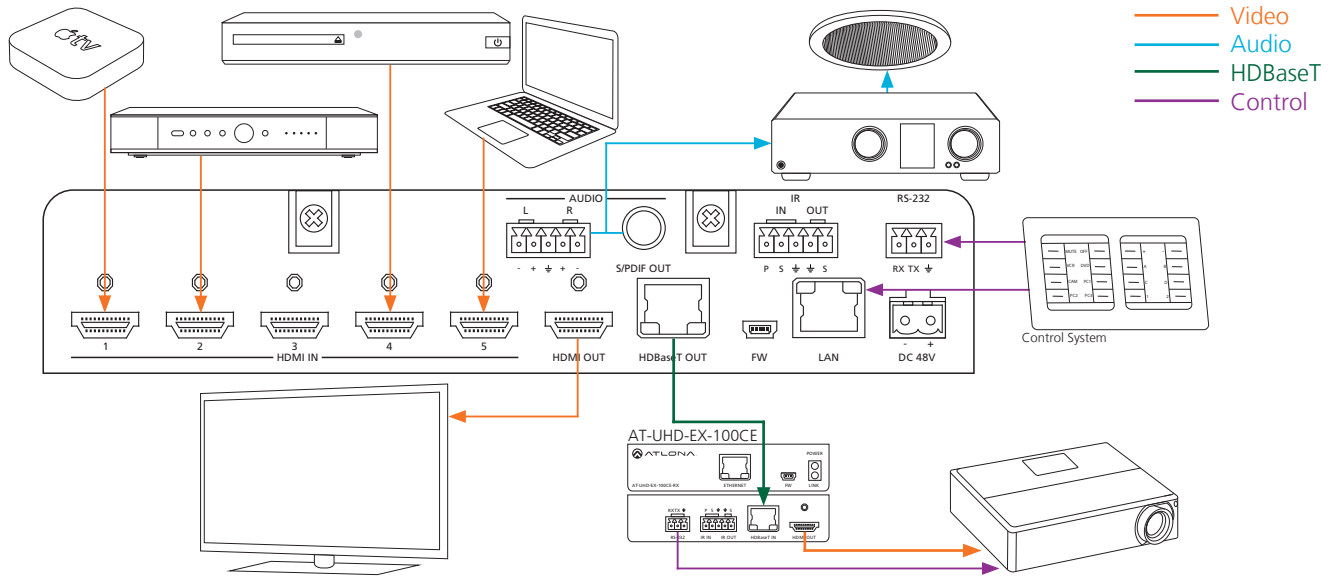

Specifications

Resolutions

Video	4096x2160@24/25/30/50*/60Hz*, 3840x2160@24/25/30/50*/60Hz* (UHD), 2048x1080p, 1080p@23.98/24/25/29.97/30/50/59.94/60Hz, 1080i@50/59.94/60Hz, 720p@50/59.94/60Hz, 576p, 576i, 480p, 480i	
VESA	2560x2048, 2560x1600, 2048x1536, 1920x1200, 1680x1050, 1600x1200, 1600x900, 1440x900, 1400x1050, 1366x768, 1360x768, 1280x1024, 1280x800, 1280x768, 1152x864, 1024x768, 800x600, 640x480	
Color Space	YUV, RGB	
Chroma Subsampling	4:4:4, 4:2:2, 4:2:0	
Color Depth	8-bit, 10-bit, 12-bit	

Audio

Formats - HDMI IN/OUT	PCM 2 Ch, LPCM 5.1, LPCM 7.1, Dolby Digital, DTS 5.1, Dolby Digital Plus, Dolby TrueHD, DTS-HD Master Audio	
Formats - S/PDIF	PCM 2 Ch, LPCM 5.1, LPCM 7.1, Dolby Digital, DTS 5.1	
Format - captive screw	Balanced analog, nominal output: +4dBu, Max output: +18dBu @ 0 dB fs, 2Ch PCM	
Sample Rate	32 kHz, 44.1 kHz, 48 kHz, 88.2 kHz, 96 kHz, 176.4 kHz, 192 kHz	

Distance (per port)

CAT5e/6 @ 4K	up to 70 meters	up to 230 feet
CAT5e/6 @ 1080p	up to 100 meters	up to 328 feet
CAT6a/7 @ 4K	up to 100 meters	up to 328 feet
HDMI IN/OUT @ 4K	up to 5 meters	up to 15 feet
HDMI IN/OUT @ 1080p	up to 10 meters	up to 30 feet

Signal

Bandwidth	10.2 Gbps	
CEC	Pass through	
HDCP	Switchable - Complaint / Non-compliant	

Temperature

Operating	0°C to 50°C	32°F to 122°F
Storage	-20°C to 60°C	-4°F to 140°F
Humidity	20 to 90% non-condensing	

Power

Consumption	22W	
Idle Consumption	9.06W	
Supply	Input: AC100~240V 50/60Hz Output: DC 48V/0.83A	

Dimension

H x W x D	44 x 222.25 x 261 (mm)	1.73 x 8.75 x 10.28 (inch)
Rack Unit	1/2 rack, 1RU	

Weight

Device	3.15 kg	1.44 lbs
--------	---------	----------

Certification

Power Supply	CE, FCC, cULus, RCM
Product	CE, FCC

**4096x2160@50/60Hz & 3840x2160@50/60Hz supported @ chroma subsampling 4:2:0 8-bit only

Safety Information

Safeguards



To reduce the risk of electric shock, do not expose this product to rain or moisture



Do not modify the wall plug. Doing so will void the warranty and safety features.



If the wall plug does not fit into your local power socket, hire an electrician to replace your obsolete socket.



This equipment should be installed near the socket outlet and the device should be easily accessible in the case it requires disconnection.

Precautions

FCC regulations state that any unauthorized changes or modifications to this equipment, not expressly approved by the manufacturer, could void the user's authority to operate this equipment.

Operate this product using only the included external power supply. Use of other power supplies could impair performance, damage the product, or cause fires.

In the event of an electrostatic discharge this device may automatically turn off. If this occurs, unplug the device and plug it back in.

Protect and route power cords so they will not be stepped on or pinched by anything placed on or against them. Be especially careful of plug-ins or cord exit points from this product.

Avoid excessive humidity, sudden temperature changes or temperature extremes.

Keep this product away from wet locations such as bathtubs, sinks, laundries, wet basements, fish tanks, and swimming pools.

Use only accessories recommended by Atlona to avoid fire, shock, or other hazards.

Unplug the product before cleaning. Use a damp cloth for cleaning and not cleaning fluid or aerosols. Such products could enter the unit and cause damage, fire, or electric shock. Some substances may also mar the finish of the product.

Never open, remove unit panels, or make any adjustments not described in this manual. Attempting to do so could expose you to dangerous electrical shock or other hazards. It may also cause damage to your product. Opening the product will void the warranty.

Do not attempt to service the unit. Disconnect the product and contact your authorized Atlona reseller or contact Atlona directly.

Atlona, Inc. (“Atlona”) Limited Product Warranty Policy

Coverage

Atlona warrants its products will substantially perform to their published specifications and will be free from defects in materials and workmanship under normal use, conditions and service.

Under its Limited Product Warranty, Atlona, at its sole discretion, will either:

- A) repair or facilitate the repair of defective products within a reasonable period of time, restore products to their proper operating condition and return defective products free of any charge for necessary parts, labor and shipping
- OR**
- B) replace and return, free of charge, any defective products with direct replacement or with similar products deemed by Atlona to perform substantially the same function as the original products
- OR**
- C) refund the pro-rated value based on the remaining term of the warranty period, not to exceed MSRP, in cases where products are beyond repair and/or no direct or substantially similar replacement products exist.

Repair, replacement or refund of Atlona’s products is the purchaser’s exclusive remedy and Atlona’s liability does not extend to any other damages, incidental, consequential or otherwise.

This Limited Product Warranty extends to the original end-user purchaser of Atlona’s products and is non-transferrable to any subsequent purchaser(s) or owner(s) of these products.

Coverage Periods

Atlona’s Limited Product Warranty Period begins on the date of purchase by the end-purchaser. The date contained on the end-purchaser’s sales or delivery receipt is the proof purchase date.

Limited Product Warranty Terms – New Products

- 10 years from proof of purchase date for hardware/electronics products purchased on or after June 1, 2013
- 3 years from proof of purchase date for hardware/electronics products purchased before June 1, 2013
- Lifetime Limited Product Warranty for all cable products

Limited Product Warranty Terms – Refurbished (B-Stock) Products

- 3 years from proof of purchase date for all Refurbished (B-Stock) hardware and electronic products purchased on or after June 1, 2013

Remedy

Atlona recommends that end-purchasers contact their authorized Atlona dealer or reseller from whom they purchased their products. Atlona can also be contacted directly. Visit www.atlona.com for Atlona’s contact information and hours of operation. Atlona requires that a dated sales or delivery receipt from an authorized dealer, reseller or end-purchaser is provided before Atlona extends its warranty services. Additionally, a return merchandise authorization (RMA) and/or case number, is required to be obtained from Atlona in advance of returns.

Atlona requires that products returned are properly packed, preferably in the original carton, for shipping. Cartons not bearing a return authorization or case number will be refused. Atlona, at its sole discretion, reserves the right to reject any products received without advanced authorization. Authorizations can be requested by calling 1-877-536-3976 (US toll free) or 1-408-962-0515 (US/international) or via Atlona’s website at www.atlona.com.

Exclusions

This Limited Product Warranty excludes:

- Damage, deterioration or malfunction caused by any alteration, modification, improper use, neglect, improper packing or shipping (such claims must be presented to the carrier), lightning, power surges, or other acts of nature.
- Damage, deterioration or malfunction resulting from the installation or removal of this product from any installation, any unauthorized tampering with this product, any repairs attempted by anyone unauthorized by Atlona to make such repairs, or any other cause which does not relate directly to a defect in materials and/or workmanship of this product.
- Equipment enclosures, cables, power supplies, batteries, LCD displays, and any accessories used in conjunction with the product(s).
- Products purchased from unauthorized distributors, dealers, resellers, auction websites and similar unauthorized channels of distribution.

Disclaimers

This Limited Product Warranty does not imply that the electronic components contained within Atlona's products will not become obsolete nor does it imply Atlona products or their electronic components will remain compatible with any other current product, technology or any future products or technologies in which Atlona's products may be used in conjunction with. Atlona, at its sole discretion, reserves the right not to extend its warranty offering in instances arising outside its normal course of business including, but not limited to, damage inflicted to its products from acts of god.

Limitation on Liability

The maximum liability of Atlona under this limited product warranty shall not exceed the original Atlona MSRP for its products. To the maximum extent permitted by law, Atlona is not responsible for the direct, special, incidental or consequential damages resulting from any breach of warranty or condition, or under any other legal theory. Some countries, districts or states do not allow the exclusion or limitation of relief, special, incidental, consequential or indirect damages, or the limitation of liability to specified amounts, so the above limitations or exclusions may not apply to you.

Exclusive Remedy

To the maximum extent permitted by law, this limited product warranty and the remedies set forth above are exclusive and in lieu of all other warranties, remedies and conditions, whether oral or written, express or implied. To the maximum extent permitted by law, Atlona specifically disclaims all implied warranties, including, without limitation, warranties of merchantability and fitness for a particular purpose. If Atlona cannot lawfully disclaim or exclude implied warranties under applicable law, then all implied warranties covering its products including warranties of merchantability and fitness for a particular purpose, shall provide to its products under applicable law. If any product to which this limited warranty applies is a "Consumer Product" under the Magnuson-Moss Warranty Act (15 U.S.C.A. §2301, ET SEQ.) or other applicable law, the foregoing disclaimer of implied warranties shall not apply, and all implied warranties on its products, including warranties of merchantability and fitness for the particular purpose, shall apply as provided under applicable law.

Other Conditions

Atlona's Limited Product Warranty offering gives legal rights, and other rights may apply and vary from country to country or state to state. This limited warranty is void if (i) the label bearing the serial number of products have been removed or defaced, (ii) products are not purchased from an authorized Atlona dealer or reseller. A comprehensive list of Atlona's authorized distributors, dealers and resellers can be found at www.atlona.com.

Atlona Product Registration

Thank you for purchasing this Atlona product. - We hope you enjoy it and will take an extra few moments to register your new purchase.

Registration creates an ownership record if your product is lost or stolen and helps ensure you'll receive notification of performance issues and firmware updates.

At Atlona, we respect and protect your privacy, assuring you that your registration information is completely secure. Atlona product registration is completely voluntary and failure to register will not diminish your limited warranty rights.

To register go to: <http://www.atlona.com/registration>