

MANUAL

- GB – Instructions for Mounting
- DE – Montageinformation
- IT – Istruzioni per il montaggio
- ES – Instrucciones para el montaje
- FI – Asennusohjeet
- FR – Instructions de montage
- NL – Montagevoorschriften
- PL – Instrukcja montażu
- RUS – Инструкция по монтажу
- ARB – عربي - طريقة التركيب
- SE – Monteringsinstruktion
- GR – Πληροφορίες συναρμολόγησης

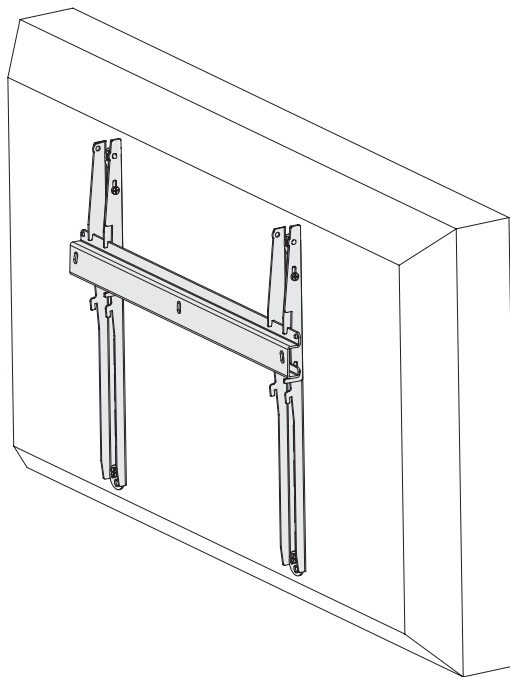

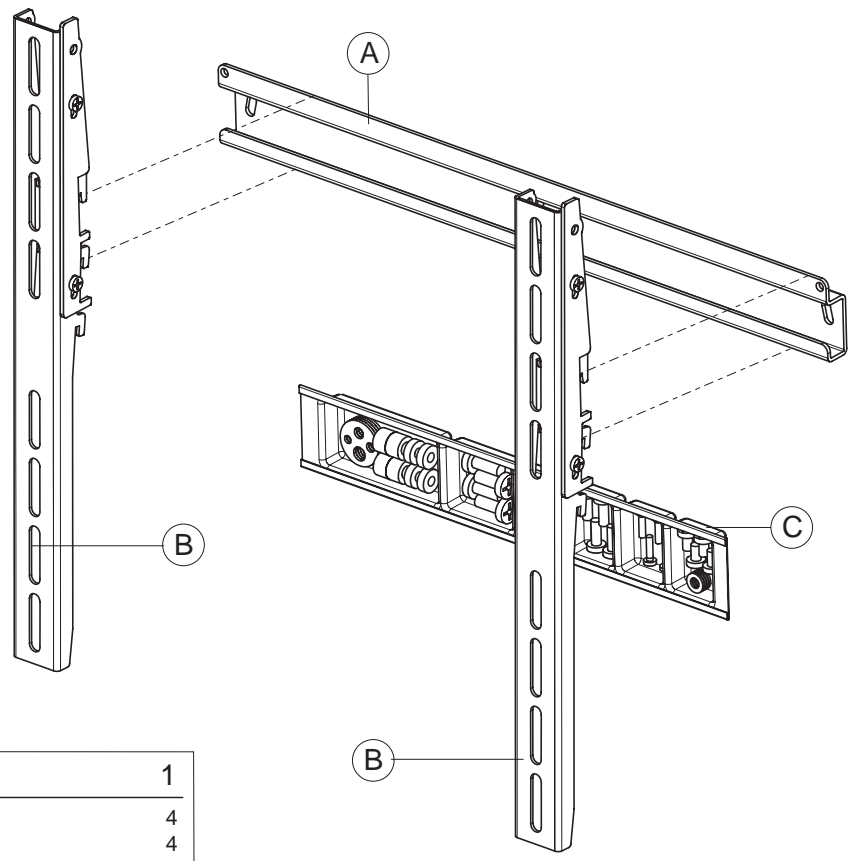
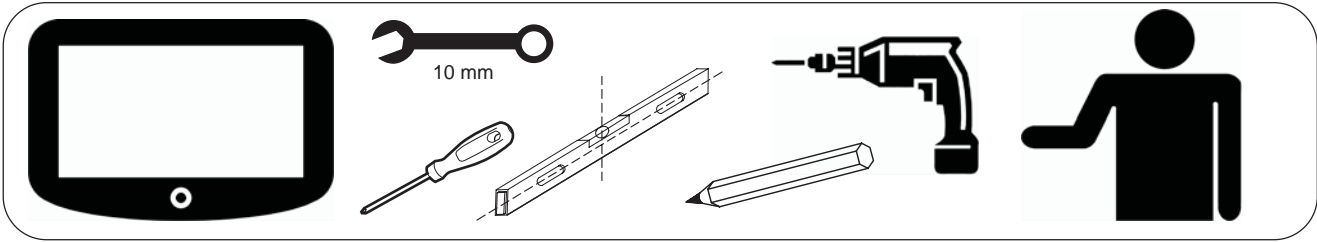

C	Screw Bag	1
	Screw M4x16	4
	Screw M6x16	4
	Screw M6x30	4
	Screw M8x20	4
	Spacer plastic d8,2/D15x10	4
	Spacer plastic d6,1/D15x5	4
	Washer 6,4	4
	Multiple washer	4
	Screw M6x10	4
	Allen Key 4	2

A	Wall Plate	1
B	Vertical Bar	2
C	Screw Bag	1

